

MediView 21.5"

MediView 23.8"

## MediView 21.5"/23.8"

User Guide Rev. 1.0

Doc. ID: 1069-6643

This page has been intentionally left blank

 MEDIVIEW - USER GUIDE

## Disclaimer

Kontron would like to point out that the information contained in this user guide may be subject to alteration, particularly as a result of the constant upgrading of Kontron products. This document does not entail any guarantee on the part of Kontron with respect to technical processes described in the user guide or any product characteristics set out in the user guide. Kontron assumes no responsibility or liability for the use of the described product(s), conveys no license or title under any patent, copyright or mask work rights to these products and makes no representations or warranties that these products are free from patent, copyright or mask work right infringement unless otherwise specified. Applications that are described in this user guide are for illustration purposes only. Kontron makes no representation or warranty that such application will be suitable for the specified use without further testing or modification. Kontron expressly informs the user that this user guide only contains a general description of processes and instructions which may not be applicable in every individual case. In cases of doubt, please contact Kontron.

This user guide is protected by copyright. All rights are reserved by Kontron. No part of this document may be reproduced, transmitted, transcribed, stored in a retrieval system, or translated into any language or computer language, in any form or by any means (electronic, mechanical, photocopying, recording, or otherwise), without the express written permission of Kontron. Kontron points out that the information contained in this user guide is constantly being updated in line with the technical alterations and improvements made by Kontron to the products and thus this user guide only reflects the technical status of the products by Kontron at the time of publishing.

Brand and product names are trademarks or registered trademarks of their respective owners.

©2023 by Kontron Europe GmbH

Kontron Europe GmbH

Gutenbergstraße 2

85737 Ismaning

Germany

[www.kontron.com](http://www.kontron.com)

## Intended Use

THIS DEVICE AND ASSOCIATED SOFTWARE ARE NOT DESIGNED, MANUFACTURED OR INTENDED FOR USE OR RESALE FOR THE OPERATION OF NUCLEAR FACILITIES, THE NAVIGATION, CONTROL OR COMMUNICATION SYSTEMS FOR AIRCRAFT OR OTHER TRANSPORTATION, AIR TRAFFIC CONTROL, LIFE SUPPORT OR LIFE SUSTAINING APPLICATIONS, WEAPONS SYSTEMS, OR ANY OTHER APPLICATION IN A HAZARDOUS ENVIRONMENT, OR REQUIRING FAIL-SAFE PERFORMANCE, OR IN WHICH THE FAILURE OF PRODUCTS COULD LEAD DIRECTLY TO DEATH, PERSONAL INJURY, OR SEVERE PHYSICAL OR ENVIRONMENTAL DAMAGE (COLLECTIVELY, "HIGH RISK APPLICATIONS").

You understand and agree that your use of Kontron devices as a component in High Risk Applications is entirely at your risk. To minimize the risks associated with your products and applications, you should provide adequate design and operating safeguards. You are solely responsible for compliance with all legal, regulatory, safety, and security related requirements concerning your products. You are responsible to ensure that your systems (and any Kontron hardware or software components incorporated in your systems) meet all applicable requirements. Unless otherwise stated in the product documentation, the Kontron device is not provided with error-tolerance capabilities and cannot therefore be deemed as being engineered, manufactured or setup to be compliant for implementation or for resale as device in High Risk Applications. All application and safety related information in this document (including application descriptions, suggested safety measures, suggested Kontron products, and other materials) is provided for reference only.

---

**CAUTION**

Handling and operation of the product is permitted only for trained personnel within a work place that is access controlled. Please follow the "General Safety Instructions for IT Equipment" supplied with the system.

---

**NOTICE**

You find the most recent version of the "General Safety Instructions" online in the download area of this product.

---

## Revision History

Revision	Brief Description of Changes	Date of Issue	Author
1.0	Initial Release	2023-Mar-10	MK

## Terms and Conditions

Kontron warrants products in accordance with defined regional warranty periods. For more information about warranty compliance and conformity, and the warranty period in your region, visit <http://www.kontron.com/terms-and-conditions>.

Kontron sells products worldwide and declares regional General Terms & Conditions of Sale, and Purchase Order Terms & Conditions. Visit <http://www.kontron.com/terms-and-conditions>.

For contact information, refer to the corporate offices contact information on the last page of this user guide or visit our website [CONTACT US](#).

## Customer Support

Find Kontron contacts by visiting: <https://www.kontron.de/support-and-services>.

## Customer Service

As a trusted technology innovator and global solutions provider, Kontron extends its embedded market strengths into a services portfolio allowing companies to break the barriers of traditional product lifecycles. Proven product expertise coupled with collaborative and highly-experienced support enables Kontron to provide exceptional peace of mind to build and maintain successful products.

For more details on Kontron's service offerings such as: enhanced repair services, extended warranty, Kontron training academy, and more visit <http://www.kontron.com/support-and-services/services>.

## Customer Comments

If you have any difficulties using this user guide, discover an error, or just want to provide some feedback, contact [Kontron support](#). Detail any errors you find. We will correct the errors or problems as soon as possible and post the revised user guide on our website.

# Symbols

The following symbols may be used in this user guide



DANGER indicates a hazardous situation which, if not avoided, will result in death or serious injury.



WARNING indicates a hazardous situation which, if not avoided, could result in death or serious injury.



NOTICE indicates a property damage message.



CAUTION indicates a hazardous situation which, if not avoided, may result in minor or moderate injury.



Electric Shock!

This symbol and title warn of hazards due to electrical shocks (> 60 V) when touching products or parts of products. Failure to observe the precautions indicated and/or prescribed by the law may endanger your life/health and/or result in damage to your material.



ESD Sensitive Device!

This symbol and title inform that the electronic boards and their components are sensitive to static electricity. Care must therefore be taken during all handling operations and inspections of this product in order to ensure product integrity at all times.



HOT Surface!

Do NOT touch! Allow to cool before servicing.



Laser!

This symbol inform of the risk of exposure to laser beam and light emitting devices (LEDs) from an electrical device. Eye protection per manufacturer notice shall review before servicing.



This symbol indicates general information about the product and the user guide.

This symbol also indicates detail information about the specific product configuration.



This symbol precedes helpful hints and tips for daily use.

## For Your Safety

Your new Kontron product was developed and tested carefully to provide all features necessary to ensure its compliance with electrical safety requirements. It was also designed for a long fault-free life. However, the life expectancy of your product can be drastically reduced by improper treatment during unpacking and installation. Therefore, in the interest of your own safety and of the correct operation of your new Kontron product, you are requested to conform with the following guidelines.

### High Voltage Safety Instructions

As a precaution and in case of danger, the power connector must be easily accessible. The power connector is the product's main disconnect device.

#### ⚠ CAUTION

##### Warning

All operations on this product must be carried out by sufficiently skilled personnel only.

#### ⚠ CAUTION



##### Electric Shock!

Before installing a non hot-swappable Kontron product into a system always ensure that your mains power is switched off. This also applies to the installation of piggybacks. Serious electrical shock hazards can exist during all installation, repair, and maintenance operations on this product. Therefore, always unplug the power cable and any other cables which provide external voltages before performing any work on this product.

Earth ground connection to vehicle's chassis or a central grounding point shall remain connected. The earth ground cable shall be the last cable to be disconnected or the first cable to be connected when performing installation or removal procedures on this product.

### Special Handling and Unpacking Instruction

#### NOTICE



##### ESD Sensitive Device!

Electronic boards and their components are sensitive to static electricity. Therefore, care must be taken during all handling operations and inspections of this product, in order to ensure product integrity at all times.

Do not handle this product out of its protective enclosure while it is not used for operational purposes unless it is otherwise protected.

Whenever possible, unpack or pack this product only at EOS/ESD safe work stations. Where a safe work station is not guaranteed, it is important for the user to be electrically discharged before touching the product with his/her hands or tools. This is most easily done by touching a metal part of your system housing.

It is particularly important to observe standard anti-static precautions when changing piggybacks, ROM devices, jumper settings etc. If the product contains batteries for RTC or memory backup, ensure that the product is not placed on conductive surfaces, including anti-static plastics or sponges. They can cause short circuits and damage the batteries or conductive circuits on the product.

## Lithium Battery Precautions

If your product is equipped with a lithium battery, take the following precautions when replacing the battery.

### ⚠ CAUTION

---

Danger of explosion if the battery is replaced incorrectly.

- ▶ Replace only with same or equivalent battery type recommended by the manufacturer.
  - ▶ Dispose of used batteries according to the manufacturer's instructions.
- 

### ⚠ CAUTION

---

Danger d'explosion si la batterie est mal remplacée.

- ▶ Remplacer uniquement par une pile de type identique ou équivalent recommandée par le fabricant.
  - ▶ Éliminez les piles usagées conformément aux instructions du fabricant.
- 

## General Instructions on Usage

In order to maintain Kontron's product warranty, this product must not be altered or modified in any way. Changes or modifications to the product, that are not explicitly approved by Kontron and described in this user guide or received from Kontron Support as a special handling instruction, will void your warranty.

This product should only be installed in or connected to systems that fulfill all necessary technical and specific environmental requirements. This also applies to the operational temperature range of the specific board version that must not be exceeded. If batteries are present, their temperature restrictions must be taken into account.

In performing all necessary installation and application operations, only follow the instructions supplied by the present user guide.

Keep all the original packaging material for future storage or warranty shipments. If it is necessary to store or ship the product then re-pack it in the same manner as it was delivered.

Special care is necessary when handling or unpacking the product. See Special Handling and Unpacking Instruction.

## Quality and Environmental Management

Kontron aims to deliver reliable high-end products designed and built for quality, and aims to complying with environmental laws, regulations, and other environmentally oriented requirements. For more information regarding Kontron's quality and environmental responsibilities, visit <http://www.kontron.com/about-kontron/corporate-responsibility/quality-management>.

## Disposal and Recycling

Kontron's products are manufactured to satisfy environmental protection requirements where possible. Many of the components used are capable of being recycled. Final disposal of this product after its service life must be accomplished in accordance with applicable country, state, or local laws or regulations.



## WEEE Compliance

The Waste Electrical and Electronic Equipment (WEEE) Directive aims to:

- ▶ Reduce waste arising from electrical and electronic equipment (EEE)
- ▶ Make producers of EEE responsible for the environmental impact of their products, especially when the product become waste
- ▶ Encourage separate collection and subsequent treatment, reuse, recovery, recycling and sound environmental disposal of EEE
- ▶ Improve the environmental performance of all those involved during the lifecycle of EEE



---

**Environmental protection is a high priority with Kontron.**

**Kontron follows the WEEE directive**

**You are encouraged to return our products for proper disposal.**

---

# Table of Contents

- Symbols .....6
- For Your Safety.....7
- High Voltage Safety Instructions .....7
- Special Handling and Unpacking Instruction .....7
- Lithium Battery Precautions..... 8
- General Instructions on Usage..... 8
- Quality and Environmental Management ..... 8
- Disposal and Recycling..... 8
- WEEE Compliance.....9
- Table of Contents .....10
- List of Tables.....11
- List of Figures .....11
- 1/ Introduction.....12
- 2/ General Safety Instructions for Electronic Devices .....13
  - 2.1. General Safety Instructions .....13
  - Additional Safety Instructions for DC Power Supply Circuits (Non-ES1/SELV).....13
  - 2.2. UL Canada: Instructions générales de sécurité pour les appareils électroniques .....14
  - Instructions de sécurité supplémentaires pour les circuits d'alimentation en courant continu (non E/S1/SELV)..... 15
  - 2.3. Cleaning of Display .....15
  - 2.4. Electromagnetic Compatibility EU.....15
  - 2.5. Electrostatic Discharge (ESD) .....16
    - 2.5.1. Grounding Methods.....16
- 3/ Scope of Delivery.....17
  - 3.1.1. Internal Type Label and Product Identification .....18
- 4/ System Specifications.....19
  - 4.1. Product Views .....19
  - 4.2. Technical Data and Environmental Specification.....21
  - 4.3. Block Diagram .....23
- 5/ Mechanical Specification .....24
  - 5.1. MediView, 21.5" Variant .....24
  - 5.2. MediView, 23.8" Variant .....24
- 6/ Connectors and LEDs .....25
  - 6.1. Overview: MediView External Connectors.....25
    - 6.1.1. Input Power Connector Versions .....25
    - 6.1.2. Power Switch and Status LEDs .....26
  - 6.2. DVI Connector .....27
  - 6.3. Display Port (DP) Connector .....27
  - 6.4. USB Port (Type B).....27
- 7/ Installation and Start .....28
  - 7.1. Mounting Instructions VESA .....28
  - 7.2. VESA Mounting.....28
  - 7.3. Startup Procedure .....29
    - 7.3.1. Starting up MediView .....29
- 8/ Maintenance .....30
  - 8.1. Cleaning.....30
- 9/ Technical Support .....31
  - 9.1. Warranty .....31

9.2. Returning Defective Merchandise ..... 32  
 List of Acronyms ..... 33  
 About Kontron ..... 34

## List of Tables

Table 1: Scope of Delivery ..... 17  
 Table 2: MediView Accessories ..... 17  
 Table 3: Technical Data ..... 21  
 Table 4: Current Rating at 24 V ..... 21  
 Table 5: Environmental Specification and Certifications ..... 22  
 Table 6: Input Power Connector Pinout (Non-Isolated Version) ..... 25  
 Table 7: Input Power Connector Pinout (Galvanically Isolated Version) ..... 25  
 Table 8: Power LED ..... 26  
 Table 9: DVI Connector Pinout ..... 27  
 Table 10: DP Connector Pinout ..... 27  
 Table 11: USB Port Pinout ..... 27  
 Table 12: List of Acronyms ..... 33

## List of Figures

Figure 1: MediView (21.5" Version) ..... 12  
 Figure 2: Example of MediView 21.5" Type Label ..... 18  
 Figure 3: Front View of MediView 21.5"/23.8" ..... 19  
 Figure 4: Rear View ..... 20  
 Figure 5: System Block Diagram ..... 23  
 Figure 6: Interfaces MediView ..... 25  
 Figure 7: Power-Switch and LEDs ..... 26

## 1/ Introduction

The MediView unit is a medical Monitor with multiple options.. It features different display types (21.5", 23.8"), a PCAP touchscreen, connectivity and Power-options.. The system is very easy to clean and disinfect, service-friendly and designed for a long life.

Figure 1: MediView (21.5" Version)



## 2/ General Safety Instructions for Electronic Devices

Please read this passage carefully and take careful note of the instructions, which have been compiled for your safety and to ensure to apply in accordance with intended regulations. If the following general safety instructions are not observed, it could lead to injuries to the operator and/or damage of the product; in cases of non-observance of the instructions Kontron Europe is exempt from accident liability, this also applies during the warranty period.

### 2.1. General Safety Instructions

The product has been built and tested according to the basic safety requirements for low voltage (LVD) applications and has left the manufacturer in safety-related, flawless condition. To maintain this condition and to also ensure safe operation, the operator must not only observe the correct operating conditions for the product but also the following general safety instructions:

- ▶ The product must be used as specified in the product documentation, in which the instructions for safety for the product and for the operator are described. These contain guidelines for setting up, installation and assembly, maintenance, transport or storage.
- ▶ The on-site electrical installation must meet the requirements of the country's specific local regulations.
- ▶ If a power cable comes with the product, only this cable should be used. Do not use an extension cable to connect the product.
- ▶ To guarantee that sufficient air circulation is available to cool the product, please ensure that the ventilation openings are not covered or blocked. If a filter mat is provided, this should be cleaned regularly. Do not place the system close to heat sources or damp places. Make sure the system is well ventilated.
- ▶ Only devices or parts which fulfill the requirements of ES1/SELV circuits (Safety Extra Low Voltage) as stipulated by IEC 62368-1 may be connected to the available interfaces.
- ▶ Before opening the device, make sure that the device is disconnected from the mains.
- ▶ Switching off the device by its power button does not disconnect it from the mains. Complete disconnection is only possible if the power cable is removed from the wall plug or from the device. Ensure that there is free and easy access to enable disconnection.
- ▶ The device may only be opened for the insertion or removal of add-on cards (depending on the configuration of the system). This may only be carried out by qualified operators.
- ▶ If extensions are being carried out, the following must be observed:
  - ▶ all effective legal regulations and all technical data are adhered to
  - ▶ the power consumption of any add-on card does not exceed the specified limitations
  - ▶ the current consumption of the system does not exceed the value stated on the product label.
- ▶ Only original accessories that have been approved by Kontron Europe can be used.
- ▶ Please note: safe operation is no longer possible when any of the following applies:
  - ▶ the device has visible damages or
  - ▶ the device is no longer functioning
 In this case the device must be switched off and it must be ensured that the device can no longer be operated.
- ▶ Handling and operation of the product is permitted only for trained personnel within a work place that is access controlled.
- ▶ CAUTION: Risk of explosion if the battery is replaced incorrectly (short-circuited, reverse-poled, wrong battery type). Dispose of used batteries according to the manufacturer's instructions.
- ▶ The ext. supply has to meet the criteria for LPS (UL/IEC 60950-1) or PS2 (UL/IEC 62368-1).

### Additional Safety Instructions for DC Power Supply Circuits (Non-ES1/SELV)

- ▶ To guarantee safe operation, please observe that:
  - ▶ no cables or parts without insulation in electrical circuits with dangerous voltage or power should be touched directly or indirectly
  - ▶ a reliable protective earthing connection is provided

- ▶ a suitable, easily accessible disconnecting device is used in the application (e.g. overcurrent protective device), if the device itself is not disconnectable
- ▶ a disconnect device, if provided in or as part of the equipment, shall disconnect both poles simultaneously
- ▶ interconnecting power circuits of different devices cause no electrical hazards
- ▶ A sufficient dimensioning of the power cable wires must be selected – according to the maximum electrical specifications on the product label – as stipulated by EN62368-1 or VDE0100 or EN60204 or UL61010-1 regulations.
- ▶ The devices do not generally fulfill the requirements for "centralized DC power systems" (UL 62368-1, Annex DVD) and therefore may not be connected to such devices!

## 2.2. UL Canada: Instructions générales de sécurité pour les appareils électroniques

Veillez lire attentivement ce passage et prendre bonne note des instructions, qui ont été compilées pour votre sécurité et pour assurer une application conforme aux réglementations prévues. Le non-respect des consignes de sécurité générales suivantes peut entraîner des blessures pour l'utilisateur et/ou des dommages pour le produit. En cas de non-respect des consignes, Kontron Europe est exonéré de la responsabilité en cas d'accident, ceci s'applique également pendant la période de garantie.

Le produit a été construit et testé conformément aux exigences de sécurité de base pour les applications basse tension (DBT) et a laissé le fabricant dans un état impeccable en matière de sécurité. Pour maintenir cet état et pour garantir également un fonctionnement sûr, l'opérateur doit non seulement respecter les conditions d'utilisation correctes du produit, mais aussi les consignes de sécurité générales suivantes :

- ▶ Le produit doit être utilisé conformément à la documentation du produit, dans laquelle sont décrites les instructions de sécurité pour le produit et pour l'opérateur. Celles-ci contiennent des directives pour la mise en place, l'installation et le montage, la maintenance, le transport ou le stockage.
- ▶ L'installation électrique sur place doit répondre aux exigences des réglementations locales spécifiques du pays.
- ▶ Si un câble d'alimentation est fourni avec le produit, seul ce câble doit être utilisé. N'utilisez pas de rallonge pour connecter le produit.
- ▶ Afin de garantir une circulation d'air suffisante pour refroidir le produit, veuillez vous assurer que les ouvertures de ventilation ne sont pas couvertes ou obstruées. Si un tapis filtrant est fourni, celui-ci doit être nettoyé régulièrement. Ne placez pas le système à proximité de sources de chaleur ou d'endroits humides. Veillez à ce que le système soit bien ventilé.
- ▶ Seuls les dispositifs ou pièces qui répondent aux exigences des circuits ES1/SELV (Safety Extra Low Voltage) comme stipulé par la norme CEI 62368-1 peuvent être connectés aux interfaces disponibles.
- ▶ Avant d'ouvrir l'appareil, assurez-vous qu'il est débranché du secteur.
- ▶ Le fait d'éteindre l'appareil par son bouton de mise en marche ne le déconnecte pas du secteur. Une déconnexion complète n'est possible que si le câble d'alimentation est retiré de la prise murale ou de l'appareil. Veillez à ce que l'accès soit libre et facile pour permettre la déconnexion.
- ▶ Le dispositif ne peut être ouvert que pour l'insertion ou le retrait de cartes supplémentaires (selon la configuration du système). Cette opération ne peut être effectuée que par des opérateurs qualifiés.
- ▶ Si des extensions sont effectuées, les points suivants doivent être respectés :
  - ▶ toutes les réglementations légales en vigueur et toutes les données techniques sont respectées
  - ▶ la consommation électrique d'une carte supplémentaire ne dépasse pas les limites spécifiées
  - ▶ la consommation actuelle du système ne dépasse pas la valeur indiquée sur l'étiquette du produit.
- ▶ Seuls les accessoires d'origine approuvés par Kontron Europe peuvent être utilisés.
- ▶ Veuillez noter que la sécurité des opérations n'est plus possible lorsque l'une des conditions suivantes s'applique :
  - ▶ l'appareil présente des dommages visibles ou
  - ▶ l'appareil ne fonctionne plus
 Dans ce cas, l'appareil doit être éteint et il faut s'assurer que l'appareil ne peut plus être utilisé.
- ▶ La manipulation et le fonctionnement du produit ne sont autorisés que pour le personnel formé dans un lieu de travail dont l'accès est contrôlé.

- ▶ ATTENTION : Risque d'explosion si la batterie est remplacée de manière incorrecte (court-circuit, inversion de polarité, mauvais type de batterie). Éliminez les piles usagées conformément aux instructions du fabricant.
- ▶ La fourniture ext. doit répondre aux critères de LPS (UL/IEC 60950-1) ou PS2 (UL/IEC 62368-1).

### Instructions de sécurité supplémentaires pour les circuits d'alimentation en courant continu (non E/S1/SELV)

- ▶ Pour garantir un fonctionnement sûr, veuillez observer ce qui suit :
  - ▶ aucun câble ou pièce non isolée dans les circuits électriques ayant une tension ou une puissance dangereuse ne doit être touché directement ou indirectement
  - ▶ une connexion fiable à la terre de protection est prévue
  - ▶ un dispositif de déconnexion approprié et facilement accessible est utilisé dans l'application (par exemple, un dispositif de protection contre les surintensités), si le dispositif lui-même n'est pas en mesure de se déconnecter
  - ▶ un dispositif de déconnexion, s'il est prévu dans ou comme partie de l'équipement, doit déconnecter les deux pôles simultanément
  - ▶ l'interconnexion des circuits d'alimentation de différents appareils ne présente aucun risque électrique
- ▶ Un dimensionnement suffisant des fils du câble d'alimentation doit être choisi - en fonction des spécifications électriques maximales figurant sur l'étiquette du produit - comme stipulé par les réglementations EN62368-1 ou VDE0100 ou EN60204 ou UL61010-1.
- ▶ Les appareils ne répondent généralement pas aux exigences des "systèmes centralisés d'alimentation en courant continu" (UL 62368-1, annexe DVD) et ne peuvent donc pas être connectés à de tels appareils !

## 2.3. Cleaning of Display

Clean the surface of your display with a dry and clean cloth to eliminate dust and particles of dirt.

### **NOTICE**

---

Particles may scratch the surface. Do not apply any pressure.  
Use commercially available glass cleaner.

---

## 2.4. Electromagnetic Compatibility EU

This product is in conformity with the protection requirements of EU Council Directive EU Council Directive 2014/30/EU on the approximation of the laws of the Member States relating to electromagnetic compatibility. If the user modifies and/or adds to the equipment (e.g. installation of add-on cards) the prerequisites for the CE conformity declaration, (safety requirements) may no longer apply.

## 2.5. Electrostatic Discharge (ESD)

A sudden discharge of electrostatic electricity can destroy static-sensitive devices or micro-circuitry. Therefore, proper packaging and grounding techniques are necessary precautions to prevent damage.

Always take the following precautions:



---

### ESD Sensitive Device!

Keep electrostatic sensitive parts in their containers until they arrive at the ESD-safe workplace. Always be properly grounded when touching a sensitive board, component, or assembly.

---

For more Information, see the Special Handling and Unpacking Instruction within this user guide and Chapter 2.5.1 Grounding Methods below.

### 2.5.1. Grounding Methods

The following measures help to avoid electrostatic damages to the device:

- ▶ Cover workstations with approved antistatic material. Always wear a wrist strap connected to the workplace, as well as properly grounded tools and equipment.
- ▶ Use antistatic mats, heel straps, or air ionizers for more protection.
- ▶ Always handle electrostatically sensitive components by their edge or by their casing.
- ▶ Avoid contact with pins, leads, or circuitry.
- ▶ Turn off power and input signals before inserting and removing connectors or connecting test equipment.
- ▶ Keep the work area free of non-conductive materials such as ordinary plastic assembly aids and styrofoam.
- ▶ Use field service tools such as cutters, screwdrivers, and vacuum cleaners that are conductive.
- ▶ Always place drives and boards with the PCB-assembly-side down on the foam.





### 3/ Scope of Delivery

This chapter describes the delivered components and optional components that can be ordered separately.

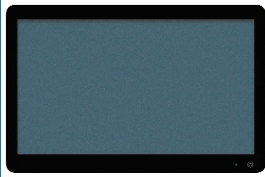
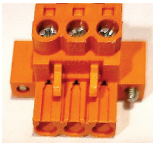

Please check that your delivery is complete and contains the items below (according to the ordered unit configuration). If you discover damaged or missing items, please contact your dealer.

**Table 1: Scope of Delivery**

	Qty	Part Number	Part Description
	1	2-A1H2-xxxx 2-A1H4-xxxx	MediView Monitor
	1	1062-2463*	Power connector for galvanically isolated MediView power input. No cable included.
	1	0-0062-3268* (with housing: EE04-100001-01)	Power connector for MediView with non-isolated power input. No cable included.

\* Depending on the ordered version of the MediView, only the appropriate power connector is provided.

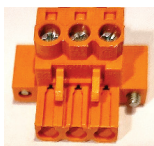
**Table 2: MediView Accessories**

	Qty	Part Number	Part Description
	1	1062-2463	Power connector for galvanically isolated MediView power input. No cable included.
	1	ER40-100008-01 (including 1062-2463)	AC power supply, 65 W, 2.7 A, 24 V output including connector for galvanically isolated MediView power input.
	1	1068-1150 (including ER40-100008-01)	AC/DC adapter for 24V DC isolated, 65W (includes power connector and power cord EU)
	1	0-0062-3268 (with housing: EE04-100001-01)	Power connector for MediView with non-isolated power input. No cable included.

	Qty	Part Number	Part Description
	1	ER40-100001-01 (including EE04-100001-01)	AC power supply, 65 W, 2.7 A, 24 V with power connector for non-isolated MediView configurations.
	1	1068-7855 (including ER40-100001-01)	AC/DC adapter for 24V DC, 65W (includes power connector and power cord EU)

### 3.1.1. Internal Type Label and Product Identification

The type label (product name, serial number, part number, production date) of your MediView system is located on the rear side of the device (refer to Figure 2 and Figure 4, pos. 1).

Figure 2: Example of MediView 21.5" Type Label



**kontron**  
Lise-Meitner-Straße 3-5 /86156 Augsburg /Germany

**Model**    MediView 21,5"

**Part Number**    2-A1H2-2002







**Rev**                0A0001

**Serial Number**    123456789





**Prod**                %d1 - A

**24V**        **2A max.**

Made in Germany

**LISTED**                **Contains FCC-ID**  
I.T.E.                    PD99260NG  
E147705

THIS DEVICE COMPLIES WITH PART 15 OF THE FCC RULES. OPERATION IS SUBJECT TO THE FOLLOWING TWO CONDITIONS:  
(1) THIS DEVICE MAY NOT CAUSE HARMFUL INTERFERENCE, AND  
(2) THIS DEVICE MUST ACCEPT ANY INTERFERENCE RECEIVED, INCLUDING INTERFERENCE THAT MAY CAUSE UNDESIRE OPERATION.  
This Class A digital apparatus complies with Canada ICES-003.  
Cet appareil numérique de la classe A est conforme à la norme NMB-003 du Canada.

## 4/ System Specifications

### 4.1. Product Views

Figure 3: Front View of MediView 21.5"/23.8"

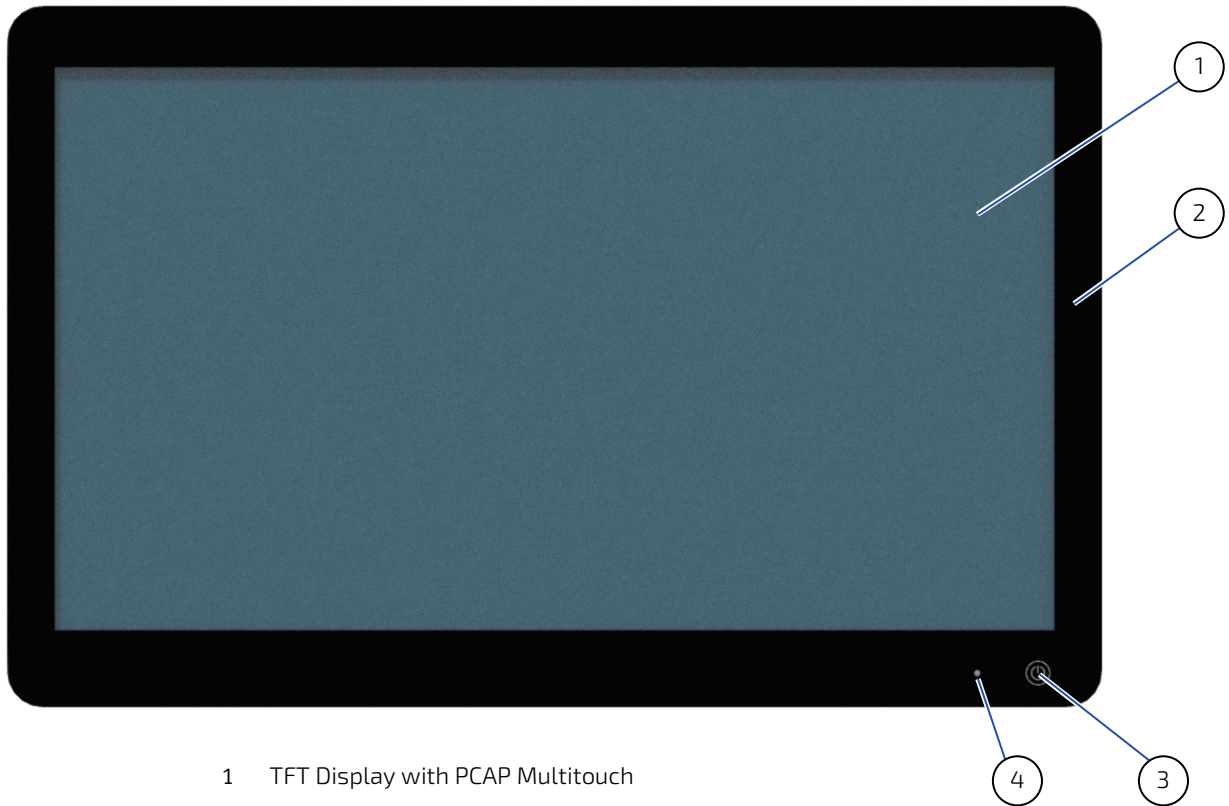

- 1 TFT Display with PCAP Multitouch
- 2 Front glass
- 3 On/Off Button
- 4 Power LED

Figure 4: Rear View

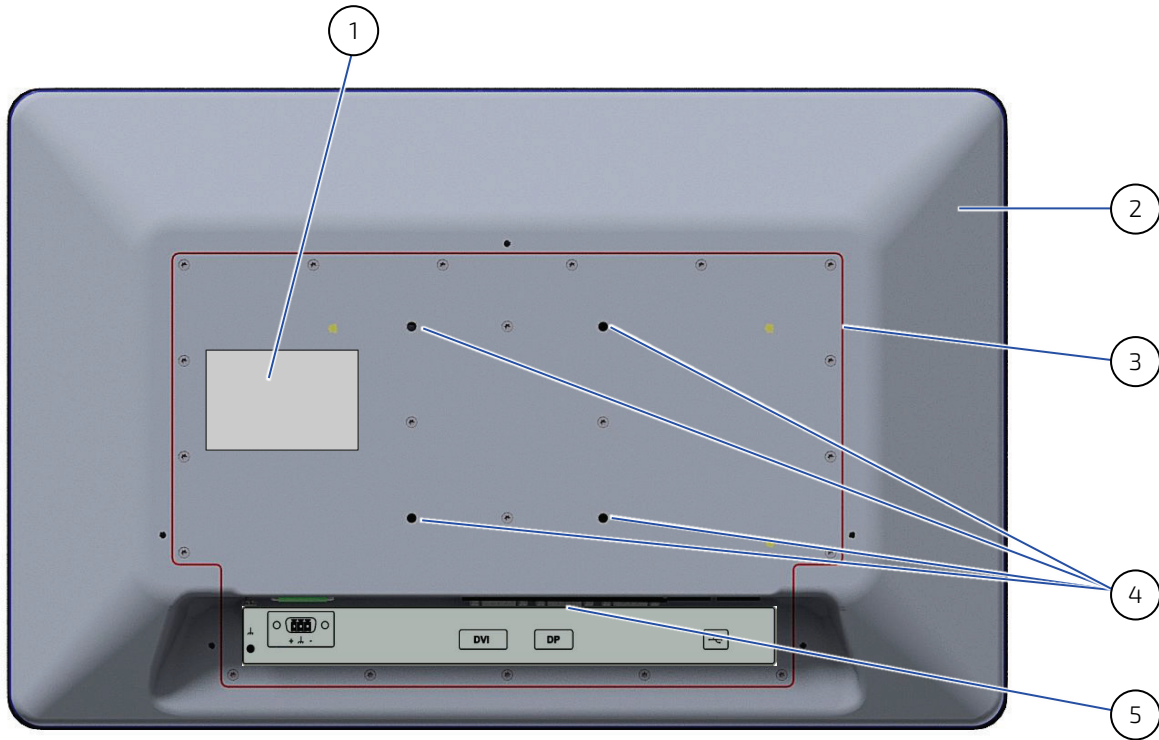

1. Type label
2. Rear housing of the MediView 21.5"
3. Service cover
4. Threaded holes for VESA mounting
5. I/O area (connectors and grounding stud)

## 4.2. Technical Data and Environmental Specification

Table 3: Technical Data

Display Size	21.5"	23.8"
Resolution (pixel)	1920x1080, Full HD	1920x1080, Full HD
Format	16:9	16:9
Contrast Ratio	1000:1	1000:1
Brightness	400 cd	400 cd
Angle View	H178°/V178°	H178°/V178°
Colors	16.7 million	16.7 million
LED Lifetime (> 50%, 25°C)	> 50.000 h	> 50.000 h
Dimensions (WxHxD-mm)	523.4 x 335.9 x 65.1	573.0 x 368.0 x 65.0
Weight	9.3 kg	10.9 kg
Protection glass	X	X
PCAP (Multitouch)	X	X
I/O Interfaces	1xDP, 1xDVI-I, Touch (optional)	1xDP, 1xDVI-I, Touch (optional)
Power Supply	24 V DC, ± 20% Galvanic isolation/non-isolated	24 V DC, ± 20% Galvanic isolation/non-isolated
Cooling	Fanless passive cooling	Fanless passive cooling
MTBF (Hours)	79000 h	79000 h

Table 4: Current Rating at 24 V

Display Size	Current [A]
21.5"	2
23.8"	2

### NOTICE

MediClient must only be installed in weather protected areas.

Table 5: Environmental Specification and Certifications

<b>Temperature</b>	Operating Temperature	0°C to +40°C
	Storage Temperature	-20°C to +70°C
<b>Altitude</b>	Operating Altitude	-500 m to 4000 m (-1640 ft to 13123 ft)
	Storage Altitude	-500 m to 5600 m (-1640 ft to 18372 ft)
<b>Humidity</b>	Operating:	20 % - 90 % @ 40°C (non-condensing)
	Storage Humidity:	10 % - 90 % @ 40°C (non-condensing)
<b>Certification</b>	CE, UL, FCC	
<b>Protection Class</b>	Front: IP65, Rear: IP22 (designed to meet)	
<b>Flammability</b>	IEC 60695-11-5 (designed to meet)	
<b>Shock, Vibration, Bump</b>	Shock DIN EN 60068-2-27	
	Operating Shock	15 G, 11 ms duration, half-sinus, 100 cycles.
	Storage Shock	30 G, 11 ms duration, half-sinus, 100 cycles.
	Vibration DIN EN 60068-2-6	
	Operating Vibration	10 – 500 Hz: 1.0 G/3axis
	Storage Vibration	10 – 150 Hz: 2.0 G/3axis
<b>EMC</b>	EN IEC 61000-6-2:2019	
	EN 55032:2015/A11:2020	
<b>FCC</b>	CFR 47 Part 15, Subpart B: The American National Standards Institute standard ANSI C63.4 is the key standard for measuring electrical and electronic equipment for showing compliance to FCC and Industry Canada regulations.	
<b>Safety</b>	UL/IEC/EN 62368-1	
<b>WEEE</b>	WEEE directive 2012/19/EU	
<b>REACH</b>	REACH according EU regulation no. 1907/2006.	
<b>Medical Safety</b>	IEC 60601-1:2005 + A1:2012 (designed to meet)	
	EN 60601-1:2006 + AC:2010 + A1:2013, Ed. 3 (designed to meet)	
<b>Medical EMC</b>	IEC 60601-1-2:2014, Ed. 4	

### 4.3. Block Diagram

Figure 5: System Block Diagram

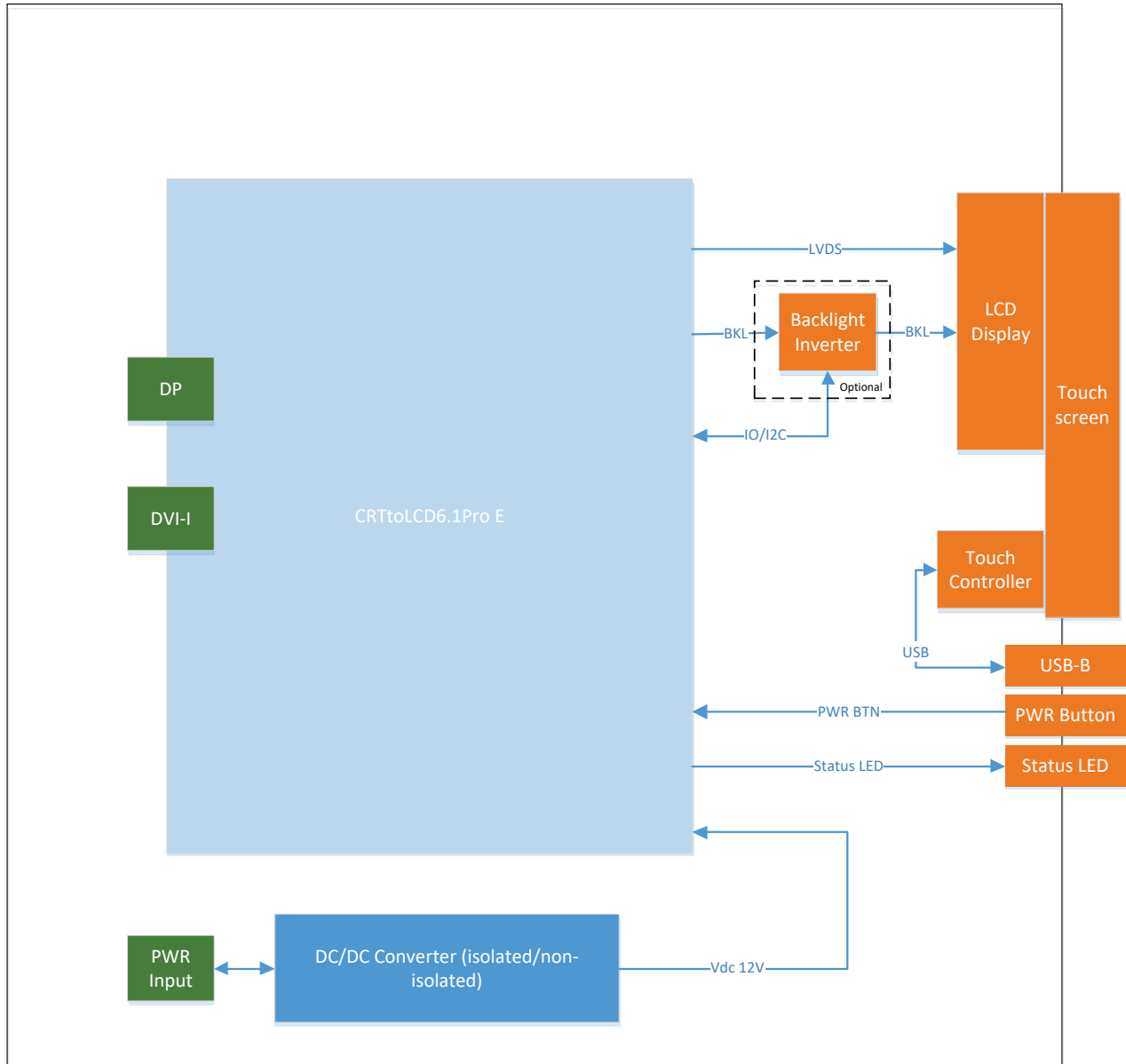

## 5/ Mechanical Specification

### 5.1. MediView, 21.5" Variant

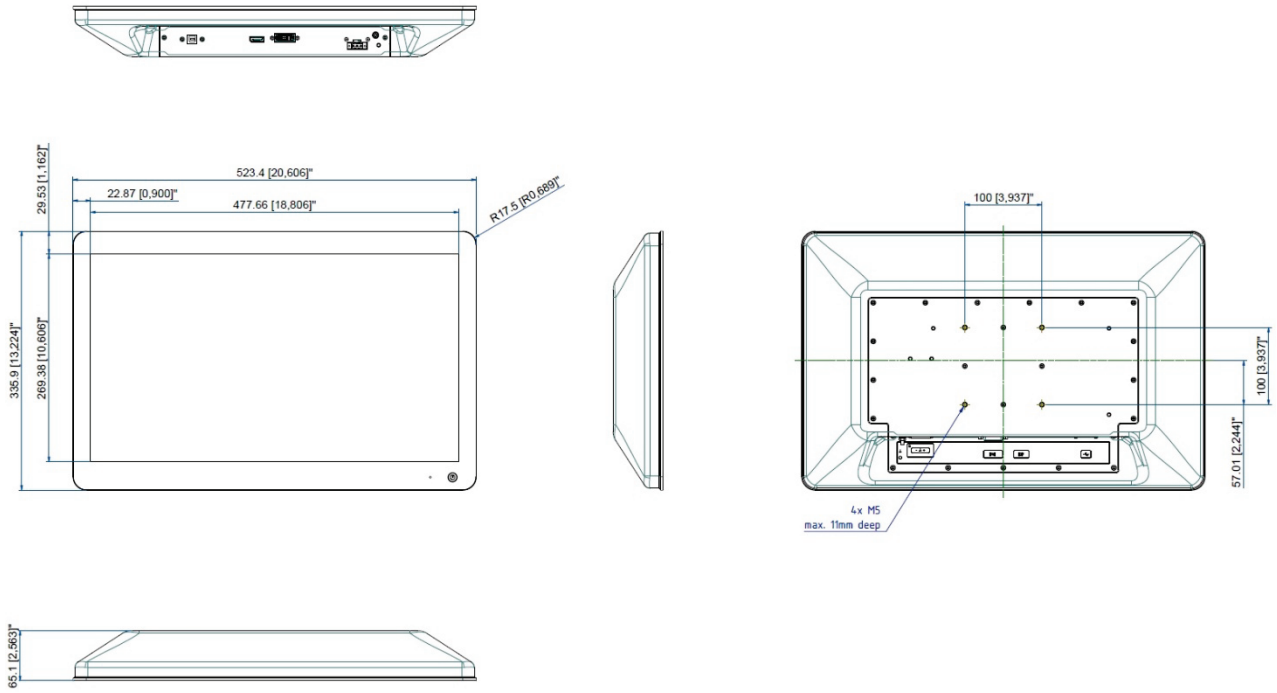

### 5.2. MediView, 23.8" Variant

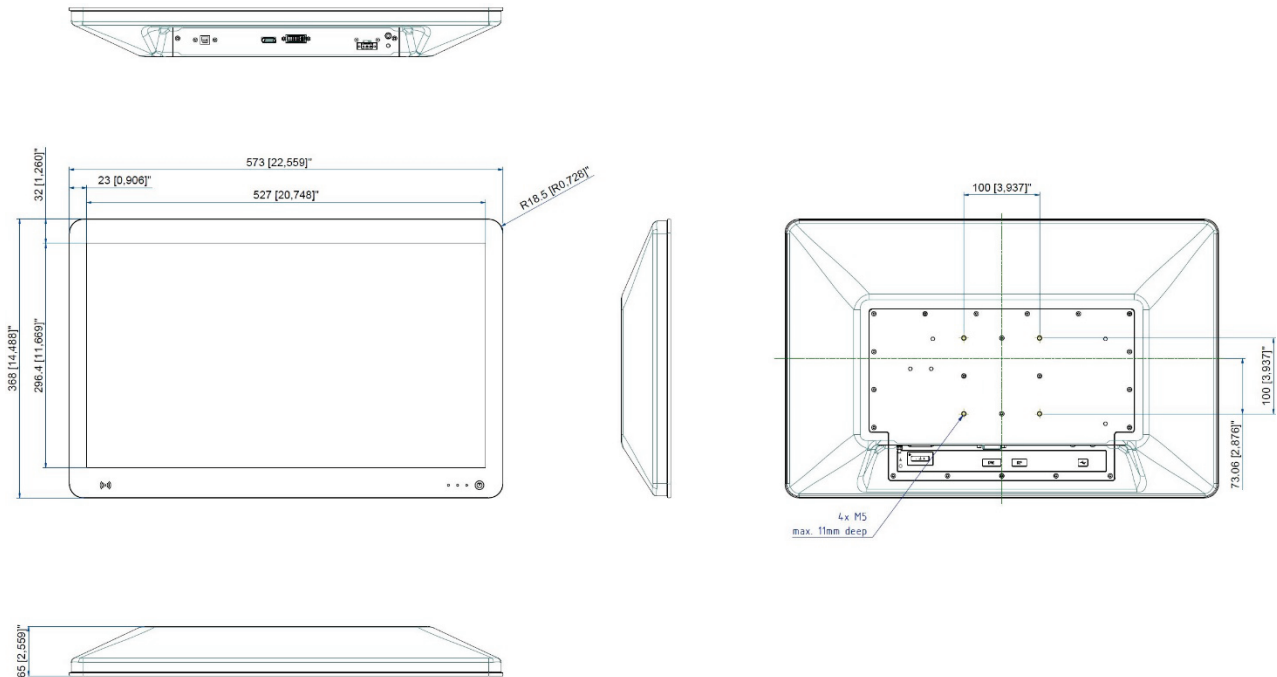



## 6/ Connectors and LEDs

### 6.1. Overview: MediView External Connectors

Figure 6: Interfaces MediView

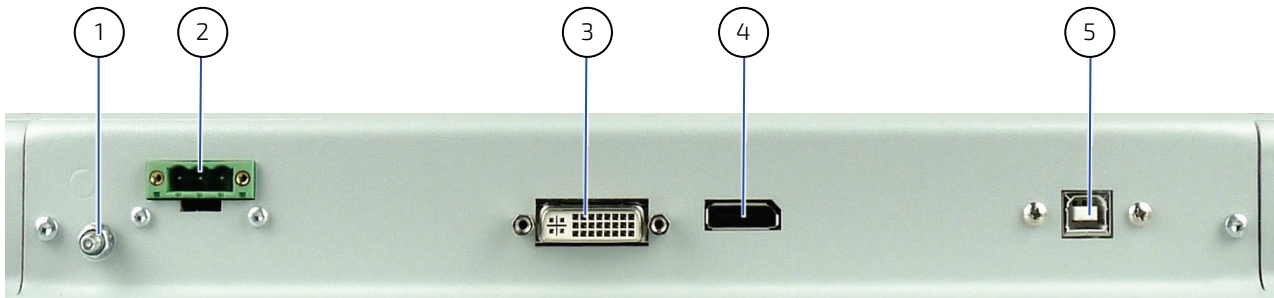

- |   |   |   |                       |
|---|---|---|-----------------------|
| 1 | Grounding stud                                  | 4 | DisplayPort Connector |
| 2 | Power connector (galvanically isolated version) | 5 | USB connector, type B |
| 3 | DVI connector                                   |   |                       |

**NOTICE**

Smart Scan feature: After detecting an input signal, the system stops the input scan and stays on the corresponding input connector.  
For switching to another input connector, a power cycle must be performed.

#### 6.1.1. Input Power Connector Versions

Table 6: Input Power Connector Pinout (Non-Isolated Version)

	Pin	Signal
	1	GND
	2	Shield
	3	VCC (24 VDC only)

Table 7: Input Power Connector Pinout (Galvanically Isolated Version)

	Pin	Signal
	1	GND (V-)
	2	Shield
	3	VCC (24 VDC only) (V+)

## 6.1.2. Power Switch and Status LEDs

Figure 7: Power-Switch and LEDs

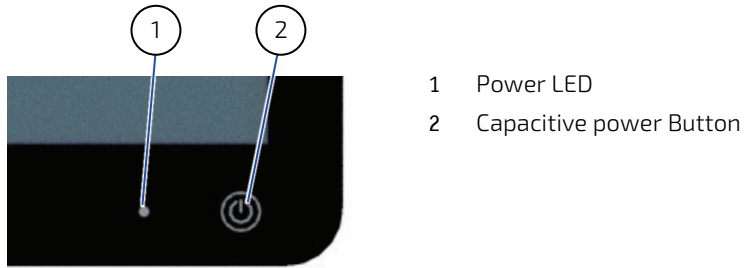

- 1 Power LED
- 2 Capacitive power Button

Table 8: Power LED

LED	Signal
Off	No Power
Green	Active

## 6.2. DVI Connector

Table 9: DVI Connector Pinout

Pin	Signal	Pin	Signal	Pin	Signal
2	Rx2+	10	Rx1+	18	Rx0+
3	GND	11	GND	19	GND
4	NC	12	NC	20	NC
5	NC	13	NC	21	NC
6	SCL	14	+5V	22	GND
7	SDA	15	GND	23	RxC+
8	NC	16	HP	24	RxC-
C1	RED	C3	BLUE	C5	GND
C2	GREEN	C4	HSYNC	C5-	GND

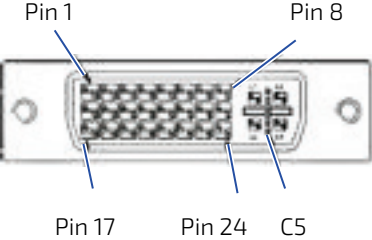

## 6.3. Display Port (DP) Connector

Table 10: DP Connector Pinout

Pin	Signal	Pin	Signal
1	TX0+	11	GND
2	GND	12	TX3-
3	TX0-	13	GND
4	TX1+	14	GND
5	GND	15	AUX+
6	TX1-	16	GND
7	TX2+	17	AUX-
8	GND	18	HPD
9	TX2-	19	GND
10	TX3+	20	PWR

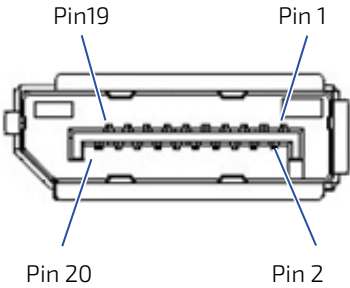

## 6.4. USB Port (Type B)

Table 11: USB Port Pinout

Pin	Signal
1	+USB_VCC
2	USB_D-
3	USB_D+
4	GND

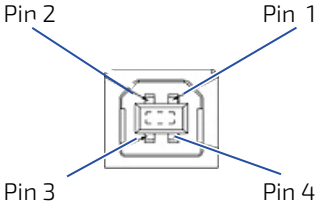

The USB port is internally connected to the touch controller.

## 7/ Installation and Start

### 7.1. Mounting Instructions VESA

To mount the MediView (VESA) use always all four VESA pattern (100/100 mm) M4 threaded holes.

#### NOTICE

Use the following screws for mounting:

- ▶ Usable thread length: 5.0 mm to 7.5 mm. Do not use screws longer than 8.7 mm
- ▶ Stainless steel screws, not oiled or lubricated, fixation torque: 3.5 Nm  
or
- ▶ Galvanized, zinc plated screws, not oiled or lubricated, fixation torque: 4.2 Nm

#### ⚠ WARNING

In the end application an external warning sign (IEC 60417-5041:2002-10) shall be applied if expected or calculated temperature at enclosure and/or heat sink exceeds TS1 Limits according to EN/IEC/UL 62368-1.

#### ⚠ CAUTION

Do Not Mount Alone

Due to the weight of the MediView, mounting alone may result in product damage or personal injury.

#### NOTICE

MediView is intended for indoor use only. To avoid product damage do not use in a sheltered outdoor, outdoor or sunlit environment.

Observe that the product is not exposed to direct sunlight (UV radiation):

- ▶ Prolonged exposure shortens field life and voids the warranty
- ▶ Short exposure may lead to higher temperatures inside the product and cause permanent damage
- ▶ Direct exposure accelerates long-term aging

For intend use in an outdoor environment or a sunlit environment, contact your Kontron representative.

#### NOTICE

Handle with care the screen may be damaged if dropped or bumped.

### 7.2. VESA Mounting

The MediView's four threaded holes are compatible with the VESA 100 pattern. When selecting a VESA mounting bracket ensure that the mounting bracket supports the VESA 100.

To mount, always use four M4 screws that are long enough to secure the MediView. The required screw length depends on the thickness of the VESA bracket used and may not require a free thread length of more than 8 mm.

#### NOTICE

Mount using all four threaded holes with screws long enough to secure the MediView.

## 7.3. Startup Procedure

The MediView starts automatically when connected to power. Before connecting the MediView to an external DC power supply, observe the General Safety Instructions for Electronic Devices within this user guide and the instructions within this chapter.

### ⚠ CAUTION

Do not switch on or handle the product if there is any visible damage.

### ⚠ CAUTION

Only connect the product to an external power supply providing the voltage type (AC or DC) and the input power (max. current) specified on the Kontron Product Label.

The external power supply must meet the requirements of ES1/PS2 according to IEC/UL 62368-1.

Connectez le produit uniquement à une alimentation externe fournissant le type de tension (AC ou DC) et la puissance d'entrée (courant max.) spécifiés sur l'étiquette du produit Kontron. L'alimentation externe doit répondre aux exigences de ES1/PS2 selon IEC/UL 62368-1.

### NOTICE

Support the power and I/O cables to minimize the strain on the connectors.

### NOTICE

The last cable to be connected must always be the power cable.



All essential drivers are available in Kontron Customer section, visit [Customer Section | Kontron Europe and Asia](#).



Observe and comply with the product's electrical specification, on the Type Label.

### 7.3.1. Starting up MediView

To connect the MediView to the supplied external AC/DC power supply, perform the following:

1. Attach the power cable's 3-pin Phoenix power connector to the power connector on the rear side of the MediView (Figure 6, pos. 2) by screwing firmly.
2. Connect the external AC/DC power supply's other cable to the mains power outlet.
3. When connected to power, the MediView starts automatically.

### ⚠ CAUTION

Ensure that the three wires (Black=ground / White=VIN 24 VDC / Green=Functional earth) are connected to the corresponding connector on the external DC power supply.

### NOTICE

Smart Scan feature: After detecting an input signal, the system stops the input scan and stays on the corresponding input connector.

For switching to another input connector, a power cycle must be performed.

## 8/ Maintenance

The MediView contains no user serviceable parts. Return the MediView to Kontron for maintenance and repair, see Chapter 9.2: Returning Defective Merchandise.

---

**CAUTION**

Opening product is prohibited due to the risk of electrical shock. There are no customer serviceable parts in the product. If problems of a technical nature occur, contact Kontron Support or return the product for repair.

---



If the product protection label is broken, the warranty is invalidated.

---

### 8.1. Cleaning

The MediClient is highly resistant to most detergents and prepared for easy cleaning and disinfection. The System was tested with 99,9% Isopropanol and Klorsept 17. Therefore we recommend those or similar alcohol or chlorine-based disinfectants. The MediClient's smooth flat joint-less surfaces are ideal for the easy removal of dirt and dust. When cleaning the display's surface, do not use any abrasive substance that might scratch or damage the screen.

---

**NOTICE**

Do not use an abrasive substance that might scratch or damage the display.

---

## 9/ Technical Support

If problems of a technical nature occur, contact Kontron Support or return the product for repair.

To contact technical support to request support via e-mail, report documentation errors, or general customer feedback, use Kontron's Contact Support form by visiting:

<http://www.kontron.com/about-kontron/company-overview/contact-us/forms/contact-support>.

In case the request form does not work or you do not get a response within 48 hours, follow up with [support@kontron.com](mailto:support@kontron.com)

Make sure you have the following product identification information on hand when you call:

- ▶ Product name,
- ▶ Product Model number
- ▶ Serial number (SN) of the unit



---

The serial number can be found on the product's type label.

---

Be ready to explain the nature of your problem to the service technician.

### 9.1. Warranty

Due to their limited service life, parts which by their nature are subject to a particularly high degree of wear (wearing parts) are excluded from the warranty beyond that provided by law.



---

If the protection label is broken, the warranty is invalidated.

---

## 9.2. Returning Defective Merchandise

All equipment returned to Kontron must have a Return of Material Authorization (RMA) number assigned exclusively by Kontron. Kontron cannot be held responsible for any loss or damage caused to the equipment received without an RMA number. The buyer accepts responsibility for all freight charges for the return of goods to Kontron's designated facility. Kontron will pay the return freight charges back to the buyer's location in the event that the equipment is repaired or replaced within the stipulated warranty period.

Follow these steps before returning any product to Kontron.

4. Visit the RMA Information website: <http://www.kontron.com/support-and-services/support/rma-information>
5. Download the RMA Request sheet for **Kontron Europe GmbH – Ismaning** and fill out the form. Take care to include a short detailed description of the observed problem or failure and to include the product identification Information (Name of product, Product number and Serial number). If a delivery includes more than one product, fill out the above information in the RMA Request form for each product.
6. Send the completed RMA-Request form to the fax or email address given on the RMA Request sheet and Kontron will provide an RMA-Number.
7. The goods for repair must be packed properly for shipping, considering shock and ESD protection.
8. Include the RMA-Number with the shipping paperwork and send the product to the delivery address provided in the RMA form or received from Kontron RMA Support.



---

**Goods returned to Kontron in non-proper packaging will be considered as customer caused faults and cannot be accepted as warranty repairs.**

---



## List of Acronyms

Table 12: List of Acronyms

<b>ECT</b>	Embedded Computing Technology
<b>ESD</b>	Electrostatic Discharge
<b>FE</b>	Functional Earth
<b>IOL</b>	IPMI-Over-LAN
<b>IOT</b>	Internet of Things
<b>IPMI</b>	Intelligent Platform Management Interface
<b>LED</b>	Light Emitting Diode
<b>LPS</b>	Limited Power Source
<b>PCAP</b>	Protective capacitive touch
<b>PCIe</b>	PCI-Express
<b>PMMA</b>	Poly(methyl methacrylate),
<b>PS</b>	Power source
<b>RMA</b>	Return Material Authorization
<b>SELV</b>	Safety Extra Low Voltage
<b>TPM</b>	Trusted Platform Module
<b>UEFI</b>	Unified Extensible Firmware Interface
<b>USB</b>	Universal Serial Bus
<b>VESA</b>	Video Electronics Standards Association
<b>WEEE</b>	Waste Electrical and Electronic Equipment



## About Kontron

Kontron is a global leader in IoT/Embedded Computing Technology (ECT). Kontron offers individual solutions in the areas of Internet of Things (IoT) and Industry 4.0 through a combined portfolio of hardware, software and services. With its standard and customized products based on highly reliable state-of-the-art technologies, Kontron provides secure and innovative applications for a wide variety of industries. As a result, customers benefit from accelerated time-to-market, lower total cost of ownership, extended product lifecycles and the best fully integrated applications.

For more information, please visit: [www.kontron.com](http://www.kontron.com)



## GLOBAL HEADQUARTERS

### Kontron Europe GmbH

Gutenbergstraße 2  
85737 Ismaning  
Germany  
Tel.: +49 821 4086-0  
Fax: +49 821 4086-111  
[info@kontron.com](mailto:info@kontron.com)