

» User Guide «

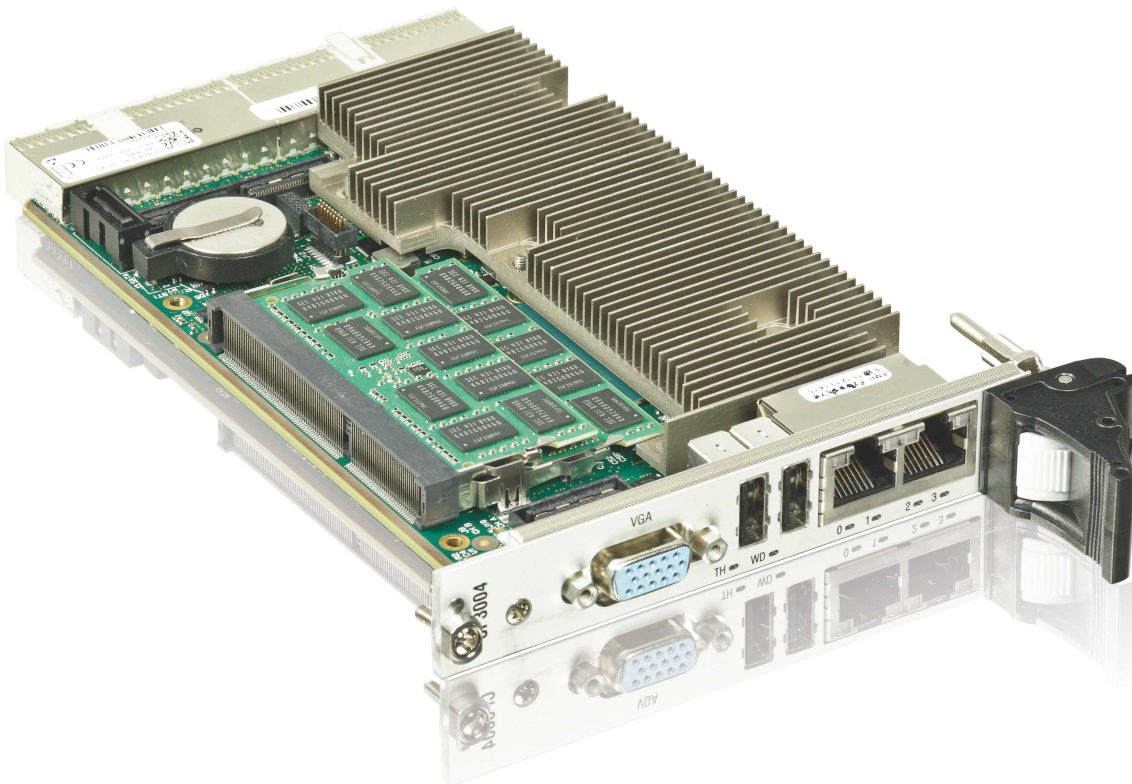

CP3004-SA

Doc. ID: 1057-3535, Rev. 1.2

Date: March 18, 2019

Revision History

Revision	Brief Description of Changes	Date of Issue
1.0	Initial issue	4-Mar-2016
1.1	Updated sections 2.7.2 and 6.6.3	29-Apr-2017
1.2	Updated table 9, VGA/DP update	18-Mar-2019

Imprint

Kontron Europe GmbH may be contacted via the following:

MAILING ADDRESS

Kontron Europe GmbH
Lise-Meitner-Str. 3-5
86156 Augsburg, Germany

TELEPHONE AND E-MAIL

+49 (0) 800-SALESKONTRON
sales@kontron.com

For further information concerning other Kontron products, please visit our Internet website: www.kontron.com.

Disclaimer

Copyright © 2016 Kontron AG. All rights reserved. All data is for information purposes only and not guaranteed for legal purposes. Information has been carefully checked and is believed to be accurate; however, no responsibility is assumed for inaccuracies. Kontron and the Kontron logo and all other trademarks or registered trademarks are the property of their respective owners and are recognized. Specifications are subject to change without notice.

Contents

Revision History	2
Imprint	2
Disclaimer	2
Contents	3
Tables	8
Figures	10
Warranty	11
Proprietary Note	11
Trademarks	11
Environmental Protection Statement	11
1 Introduction	12
1.1 Board Overview	12
1.2 System Expansion Capabilities	13
1.2.1 CP3004-HDD Module (8 HP and 12 HP)	13
1.2.2 CP3004-XMC Module (8 HP)	13
1.2.3 CP-RI03-04 Rear I/O Module	13
1.2.4 SATA Flash Module	13
1.2.5 Smart Extension Module	13
1.3 Board Diagrams	13
1.3.1 Functional Block Diagram	14
1.3.2 Front Panel	15
1.3.3 Board Layout	16
1.4 Technical Specification	17
1.5 Standards	21
1.6 Related Publications	22
2 Functional Description	23
2.1 Processor and Chipset	23
2.1.1 Integrated Processor Graphics Controller	24
2.2 Memory	24
2.3 Watchdog Timer	24
2.4 Battery	24
2.5 Flash Memory	25
2.5.1 SPI Boot Flash for uEFI BIOS	25
2.5.2 SATA Flash Module	25
2.6 Trusted Platform Module 1.2	25
2.7 Board Interfaces	25
2.7.1 Front Panel LEDs	25
2.7.1.1 System Status LEDs	26

2.7.1.2	General Purpose LEDs	26
2.7.2	USB Interfaces	27
2.7.3	VGA Interface	27
2.7.4	Serial Ports	27
2.7.5	Gigabit Ethernet.....	28
2.7.6	SATA Interfaces	28
2.7.7	Debug Interface	28
2.7.8	CompactPCI Interface	29
2.7.8.1	Board Functionality when Installed in System Slot.....	29
2.7.8.2	Board Functionality when Installed in Peripheral Slot (Passive Mode)	29
2.7.8.3	Front/Rear I/O Configuration.....	29
2.7.8.4	Board Insertion/Replacement under Power	29
2.7.8.5	Power Ramping	30
2.7.8.6	ENUM# Interrupt	30
2.7.9	CompactPCI Connectors J1 and J2.....	31
2.7.9.1	CompactPCI Connector Keying	31
2.7.9.2	CompactPCI Connectors J1 and J2 Pinouts	32
2.7.9.3	Optional Rear I/O Interface.....	35
2.7.9.4	Rear I/O Pin Description.....	38
3	Configuration	42
3.1	DIP Switch Configuration	42
3.2	System Write Protection	43
3.3	CP3004-SA-Specific Registers	43
3.3.1	Status Register 0 (STAT0)	44
3.3.2	Status Register 1 (STAT1)	45
3.3.3	Control Register 0 (CTRL0)	46
3.3.4	Control Register 1 (CTRL1)	47
3.3.5	Device Protection Register (DPROT).....	48
3.3.6	Reset Status Register (RSTAT)	49
3.3.7	Board Interrupt Configuration Register (BICFG)	50
3.3.8	Status Register 2 (STAT2)	51
3.3.9	Board ID High-Byte Register (BIDH).....	52
3.3.10	Board and PLD Revision Register (BREV).....	52
3.3.11	Geographic Addressing Register (GEOAD)	52
3.3.12	Watchdog Timer Control Register (WTIM)	53
3.3.13	Board ID Low-Byte Register (BIDL)	55
3.3.14	LED Configuration Register (LCFG)	55
3.3.15	LED Control Register (LCTRL)	56
3.3.16	General Purpose Output Register (GPOUT).....	57
3.3.17	General Purpose Input Register (GPIN).....	57
4	Power Considerations	58
4.1	CP3004-SA Voltage Ranges.....	58
4.2	Power Consumption of the CP3004-SA.....	58
4.3	Power Consumption of CP3004-SA Accessories	59

4.4	Maximum Power Consumption of XMC Modules	60
4.5	Current Limits	60
5	Thermal Considerations	61
5.1	Operational Limits for the CP3004-SA	62
6	CP3004-HDD Extension Module	64
6.1	Overview.....	64
6.2	Technical Specifications	64
6.3	CP3004-HDD Module Functional Block Diagram	66
6.4	Front Panel of the CP3004-SA with CP3004-HDD Module.....	67
6.5	CP3004-HDD Module Layout	68
6.6	Module Interfaces	69
6.6.1	DisplayPort Interfaces	69
6.6.2	Gigabit Ethernet Interface	69
6.6.3	USB Interface	69
6.6.4	Serial Port.....	70
6.6.5	CFast Interface.....	70
6.6.6	SATA Interface	70
7	CP3004-XMC Extension Module	71
7.1	Overview.....	71
7.2	Technical Specifications	71
7.3	CP3004-XMC Module Functional Block Diagram	72
7.4	Front Panel of the CP3004-SA with CP3004-XMC Module	73
7.5	CP3004-XMC Module Layout.....	74
7.6	Module Interfaces	75
7.6.1	CFast Interface	75
7.6.2	XMC Interface	75
8	CP-RI03-04 Rear Transition Module	76
8.1	Overview.....	76
8.2	Technical Specifications	76
8.3	CP-RI03-04 Front Panels	77
8.4	CP-RI03-04 Rear Transition Module Layout	78
8.5	Module Interfaces	80
8.5.1	USB Interfaces	80
8.5.2	VGA Interface	80
8.5.3	Gigabit Ethernet Interface	80
8.5.4	COM Interface	80
8.5.5	Peripheral Control Interface	81
8.5.6	SATA Interfaces	81
8.5.7	Rear I/O Interface on CompactPCI Connector rJ2	82

9	SATA Flash Module	84
9.1	Overview	84
9.2	Technical Specifications	84
9.3	SATA Flash Module Layout	84
10	Smart Extension Module	85
10.1	Overview	85
10.2	Technical Specifications	85
10.3	Smart Extension Module Layout	85
10.4	Module Interfaces	85
10.4.1	USB Interface	85
10.4.2	SATA Interface	85
11	Installation	86
11.1	Safety	86
11.2	General Instructions on Usage	86
11.3	Board Installation	86
11.3.1	Standard Board Insertion	87
11.3.2	Standard Board Removal	87
11.4	Installation of CP3004-SA Peripheral Devices	88
11.4.1	SATA Flash Module Installation	90
11.4.2	Smart Extension Module Installation	91
11.4.3	Installation of External SATA Devices	91
11.4.4	2.5" HDD/SSD Installation	91
11.4.5	XMC Module Installation	92
11.4.6	CFast Card Installation	95
11.4.7	Rear I/O Device Installation	96
11.5	Battery Replacement	96
12	uEFI BIOS	97
12.1	Starting the uEFI BIOS	97
12.2	Setup Menus	98
12.2.1	Main Setup Menu	98
12.2.2	Advanced Setup Menu	99
12.2.3	Security Setup Menu	101
12.2.3.1	Remember the Password	101
12.2.4	Boot Setup Menu	101
12.2.5	Save & Exit Setup Menu	102
12.3	The uEFI Shell	103
12.3.1	Introduction, Basic Operation	103
12.3.1.1	Entering the uEFI Shell	103
12.3.1.2	Exiting the uEFI Shell	103
12.3.2	Kontron-Specific uEFI Shell Commands	104
12.4	uEFI Shell Scripting	106
12.4.1	Startup Scripting	106
12.4.2	Create a Startup Script	106

12.4.3	Examples of Startup Scripts	106
12.4.3.1	Automatic Booting from USB Flash Drive	106
12.4.3.2	Execute Shell Script on Other Harddrive	106
12.4.3.3	Enable Watchdog and Control PXE Boot	106
12.4.3.4	Handling the Startup Script in the SPI Boot Flash	107
12.5	Updating the uEFI BIOS	108
12.5.1	Updating Procedure	108
12.5.2	uEFI BIOS Recovery	108
12.5.3	Determining the Active Flash	108

Tables

1	CP3004-SA Main Specifications	17
2	Standards	21
3	Related Publications	22
4	Features of the Processors Supported on the CP3004-SA	23
5	System Status LEDs Function	26
6	General Purpose LEDs Function	26
7	POST Code Sequence	27
8	POST Code Example	27
9	CompactPCI Connector J1 System Slot Pinout	32
10	CompactPCI Connector J1 Peripheral Slot Pinout	33
11	CompactPCI Connector J2 Pinout (CP3004-SA Front I/O Vers.)	34
12	Rear I/O CompactPCI Connector J2 Pinout (CP3004-SA Rear I/O Vers.)	36
14	GPIO Signal Description	37
13	CompactPCI Rear I/O Connector J2 Signals	37
15	COMA and COMB Signal Description	38
16	GPIO Signal Description	38
17	VGA Signal Description	39
18	Gigabit Ethernet Signal Description	40
19	SATA Signal Description	40
20	USB Signal Description	41
21	Power Supply and Power Management Signal Description	41
22	DIP Switch SW1 Functionality	42
23	CP3004-SA-Specific Registers	43
24	Status Register 0 (STAT0)	44
25	Status Register 1 (STAT1)	45
26	Control Register 0 (CTRL0)	46
27	Control Register 1 (CTRL1)	47
28	Device Protection Register (DPROT)	48
29	Reset Status Register (RSTAT)	49
30	Board Interrupt Configuration Register (BICFG)	50
31	Status Register 2 (STAT2)	51
32	Board ID High-Byte Register (BIDH)	52
33	Board and PLD Revision Register (BREV)	52
34	Geographic Addressing Register (GEOAD)	52
35	Watchdog Timer Control Register (WTIM)	53
36	Board ID Low-Byte Register (BIDL)	55
37	LED Configuration Register (LCFG)	55
38	LED Control Register (LCTRL)	56
39	General Purpose Output Register (GPOUT)	57
40	General Purpose Input Register (GPIN)	57
41	DC Operational Input Voltage Range	58
42	CP3004-SA Power Consumption	59
43	Power Consumption of CP3004-SA Accessories	59
44	XMC Module Current	60
45	CP3004-HDD Module Specifications	64

46	Serial Port Connector J8 Pinout	70
47	CP3004-XMC Module Specifications	71
48	CP-RI03-04 Rear Transition Module Specifications	76
49	Serial Port Connectors J2 (COMB) and J3 (COMA) Pinout	80
50	Peripheral Control Connector J13 Pinout	81
52	Rear I/O Signal Description	83
51	Rear I/O CompactPCI Connector rJ2 Pinout	83
53	SATA Flash Module Specifications	84
54	Smart Extension Module Specifications	85
55	Navigation	97
56	Main Setup Menu Sub-Screens and Functions	98
57	Advanced Setup Menu Sub-Screens and Functions	99
58	Security Setup Menu Functions	101
59	Modes of Security	101
61	Save & Exit Setup Menu Sub-Screens and Functions	102
60	Boot Setup Menu Sub-Screens and Functions	102
62	Kontron-Specific uEFI Shell Commands	104

Figures

1	CP3004-SA Functional Block Diagram	14
2	4 HP CP3004-SA Front Panel	15
3	4 HP CP3004-SA Board Layout (Top View)	16
4	4 HP CP3004-SA Board Layout (Bottom View)	16
5	CPCI Connectors J1/J2	31
6	DIP Switch SW1	42
7	CP3004-SA with Intel® Core™ i7-5700EQ, 2.6 GHz	62
8	CP3004-SA with Intel® Core™ i5-4410E, 2.9 GHz	63
9	CP3004-SA with Intel® Core™ i3-4112E, 1.8 GHz	63
10	CP3004-HDD Module Functional Block Diagram	66
11	Front Panel of the 8 HP and 12 HP CP3004-SA with CP3004-HDD Module	67
12	CP3004-HDD Module Layout for 8 HP Board Version (Top View)	68
13	CP3004-HDD Module Layout for 12 HP Board Version (Top View)	68
14	SATA Adapter for 2.5" SATA HDD/SSD (Top view)	69
15	Serial Port Connector J8	70
16	CP3004-XMC Module Functional Block Diagram	72
17	Front Panel of the 8 HP and 12 HP CP3004-SA with CP3004-XMC Module	73
18	CP3004-XMC Module Layout for 8 HP Board Version (Top View)	74
19	CP3004-XMC Module Layout for 8 HP Board Version (Bottom View)	74
20	CP-RI03-04 4HP and 8HP Front Panels	77
21	4HP CP-RI03-04 Rear Transition Module Layout	78
22	8HP CP-RI03-04 Rear Transition Module Layout	79
23	Rear I/O CompactPCI Connector rJ2	82
24	SATA Flash Module Layout (Top and Bottom Views)	84
25	Smart Extension Module Layout (Top View)	85
26	4 HP CP3004-SA with SATA Flash Module	88
27	4 HP CP3004-SA with Smart Extension Module	88
28	8 HP CP3004-SA with CP3004-HDD Module	89
29	12 HP CP3004-SA with CP3004-HDD Module and SATA Adapter Module	89
30	8 HP CP3004-SA with CP3004-XMC Module	90
31	Screws Securing the Front Panel and the CP3004-XMC to the CP3004-SA	92
32	Screws Securing the XMC Module to the CP3004-XMC Extension Module	93
33	CP3004-SA Board with CP3004-XMC Extension Module and XMC Module	93
34	CP3004-SA with Front Panel, CP3004-XMC Extension Module and XMC Module	94

Warranty

This Kontron product is warranted against defects in material and workmanship for the warranty period from the date of shipment. During the warranty period, Kontron will at its discretion decide to repair or replace defective products.

Within the warranty period, the repair of products is free of charge as long as warranty conditions are observed.

The warranty does not apply to defects resulting from improper or inadequate maintenance or handling by the buyer, unauthorized modification or misuse, operation outside of the product's environmental specifications or improper installation or maintenance.

Kontron will not be responsible for any defects or damages to other products not supplied by Kontron that are caused by a faulty Kontron product.

Proprietary Note

This document contains information proprietary to Kontron. It may not be copied or transmitted by any means, disclosed to others, or stored in any retrieval system or media without the prior written consent of Kontron or one of its authorized agents.

The information contained in this document is, to the best of our knowledge, entirely correct. However, Kontron cannot accept liability for any inaccuracies or the consequences thereof, or for any liability arising from the use or application of any circuit, product, or example shown in this document.

Kontron reserves the right to change, modify, or improve this document or the product described herein, as seen fit by Kontron without further notice.

Trademarks

This document may include names, company logos and trademarks, which are registered trademarks and, therefore, proprietary to their respective owners.

Environmental Protection Statement

This product has been manufactured to satisfy environmental protection requirements where possible. Many of the components used (structural parts, printed circuit boards, connectors, batteries, etc.) are capable of being recycled.

Final disposition of this product after its service life must be accomplished in accordance with applicable country, state, or local laws or regulations.

1 Introduction

1.1 Board Overview

The CP3004-SA is a highly integrated 3U CompactPCI® processor board based on the 4th and 5th generation Intel® Core™ i7/i5/i3 processor in combination with the Intel® QM87 Chipset.

With the powerful, 4th and 5th generation quad-core Intel® Core™ i7, dual-core Intel® Core™ i5 and dual-core Intel® Core™ i3 processors, the CP3004-SA offers extraordinary performance-per-watt values and is an ideal backbone for powerful network-intensive applications providing virtualization (VT-X, VT-D) and highest graphics performance. The new-generation graphics controller has up to 40 execution units providing OpenCL 1.2/OpenGL 4.0 and triple independent display support.

The Intel® Advanced Vector Extensions AVX 2.0 enhancements provide a huge performance improvement in floating-point-intensive computations, which are a key part of digital signal and image processing applications such as medical imaging and radar or sonar.

Two SODIMM sockets are available on the CP3004-SA to provide up to 16 GB dual-channel, DDR3L memory with Error Checking and Correction (ECC) running at 1600 MT/s. The graphics controller and the memory controller are integrated in the processor. Furthermore, an external HDD/SSD and either a SATA Flash module with up to 32 GB SLC NAND flash memory or a Smart Extension Module (SATA/USB 2.0 adapter) can be integrated onto the CP3004-SA. The board comes with two Gigabit Ethernet ports, one VGA interface, two COM ports, six SATA interfaces, four USB 2.0 ports, one USB 3.0 port, two DisplayPort interfaces, and one x8 PCI Express 2.0 XMC interface. The CP3004-SA provides support for one 8 HP I/O extension module such as the CP3004-HDD or the CP3004-XMC as well as one rear I/O module such as the CP-RI03-04.

The board supports a configurable 32-bit/ 33 MHz (66 MHz on request) PCI/PCI-X hot swap CompactPCI interface. When installed in the system slot, the interface is enabled, and when installed in a peripheral slot, the CP3004-SA is isolated from the CompactPCI bus. The CP3004-SA further provides safety and security features via a Trusted Platform Module (TPM) 1.2. The board fits into all applications situated in industrial environments, including I/O intensive applications where only one slot is available for the CPU, making it a perfect core technology for long-life applications. Components which have high temperature tolerance have been selected from embedded technology programs, and therefore offer long-term availability.

Delivering a stable product based on Intel®'s embedded product line, the CP3004-SA ensures long-term availability. This eliminates the risk of unplanned design changes and unexpected expensive application modification. While minimizing deployment risks, the CP3004-SA provides a broad range of software support to ease the process of product integration and maximize the competitive advantage of meeting the time-to-market window.

The board is offered with various board support packages including Windows, VxWorks and Linux operating systems. For further information concerning the operating systems available for the CP3004-SA, please contact Kontron.

1.2 System Expansion Capabilities

1.2.1 CP3004-HDD Module (8 HP and 12 HP)

The CP3004-HDD module for the 8 HP CP3004-SA version provides various I/O ports. On the front panel, it includes two DisplayPort connectors, one Gigabit Ethernet port, one USB 3.0 port, and one RS-232 COM port. Onboard ports include one SATA connector for SATA 2.5" HDD or SSD devices as well as a CFast card socket. As a further extension capability of the CP3004-SA to 12 HP, a SATA adapter module is available for use in conjunction with the CP3004-HDD module to provide an additional SATA connector for a 2.5" SATA HDD/SSD device. The 12 HP CP3004-SA does not provide a CFast card socket.

For further information about the CP3004-HDD module, refer to Chapter 6.

1.2.2 CP3004-XMC Module (8 HP)

The CP3004-XMC module for the 8 HP CP3004-SA version provides one XMC mezzanine interface for support of one x8, x4 or x1 PCI Express 2.0 XMC module. Support of one XMC module with two x4 or x1 PCI Express 2.0 interfaces is also provided upon request. In addition, the CP3004-XMC module provides a socket for CFast memory cards.

For further information about the CP3004-XMC module, refer to Chapter 7.

1.2.3 CP-RI03-04 Rear I/O Module

The CP-RI03-04 rear I/O module has been designed for use with the CP3004-SA board from Kontron and provides comprehensive rear I/O functionality.

For further information about the CP-RI03-04 rear I/O module, refer to Chapter 8.

1.2.4 SATA Flash Module

The 4 HP CP3004-SA provides support for up to 32 GB of SLC NAND flash memory in combination with an optional SATA Flash module, which is connected to an onboard connector.

For further information about the SATA Flash module, refer to Chapter 9.

1.2.5 Smart Extension Module

The Smart Extension Module expands the onboard I/O capability and provides one additional SATA cable connector as well as one USB 2.0 connector thereby facilitating the connection to system-internal USB and SATA devices.

For further information about the SATA Flash module, refer to Chapter 10.

1.3 Board Diagrams

The following diagrams provide additional information concerning board functionality and component layout.

1.3.1 Functional Block Diagram

Figure 1: CP3004-SA Functional Block Diagram

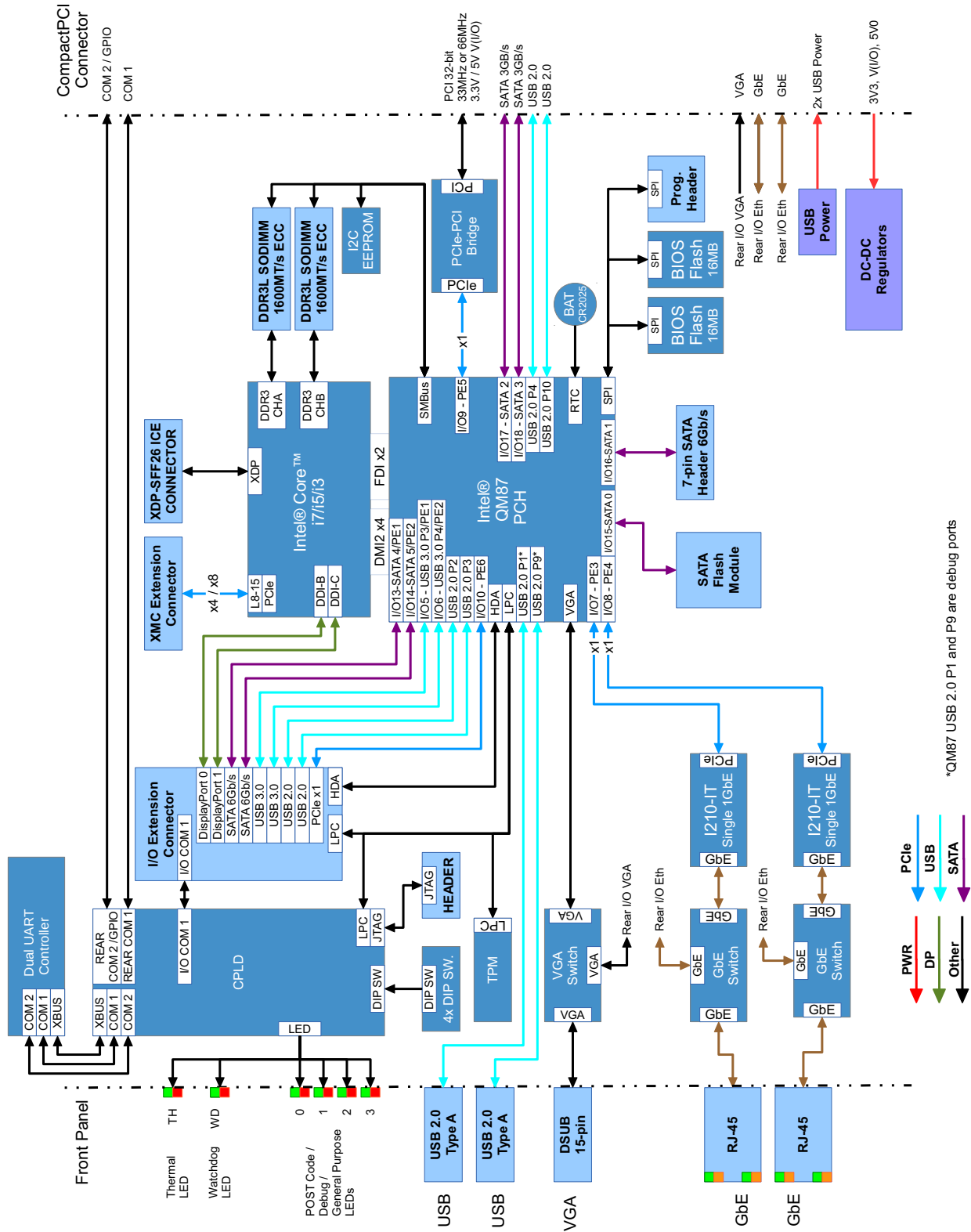

*QM87 USB 2.0 P1 and P9 are debug ports

1.3.2 Front Panel

Figure 2: 4 HP CP3004-SA Front Panel

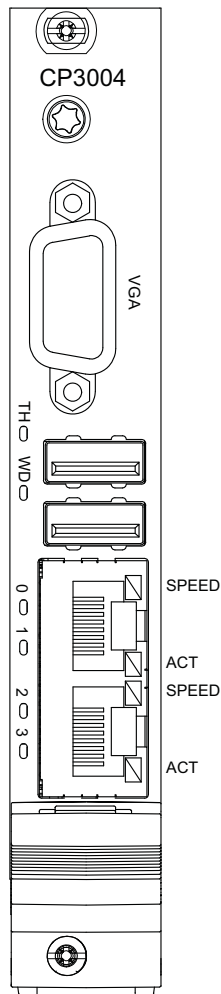

System Status LEDs

TH (red/green): Temperature Status
 WD (green): Watchdog Status

General Purpose LEDs

LED3..0 (red/green/red+green): General Purpose/POST Code

Note: If the General Purpose LEDs 3..0 are lit red during boot-up, a failure is indicated before the uEFI BIOS has started.

Integral Ethernet LEDs

ACT (green): Ethernet Link/Activity
 SPEED (orange): 1000BASE-T Ethernet Speed
 SPEED (green): 100BASE-TX Ethernet Speed
 SPEED (off) + ACT on: 10BASE-T Ethernet Speed

Note: For information regarding the front panel of the 8 HP or 12 HP CP3004-SA with a CP3004-HDD module, refer to Chapter 6.

For information regarding the front panel of the 8 HP CP3004-SA with a CP3004-XMC module, refer to Chapter 7.

1.3.3 Board Layout

Figure 3: 4 HP CP3004-SA Board Layout (Top View)

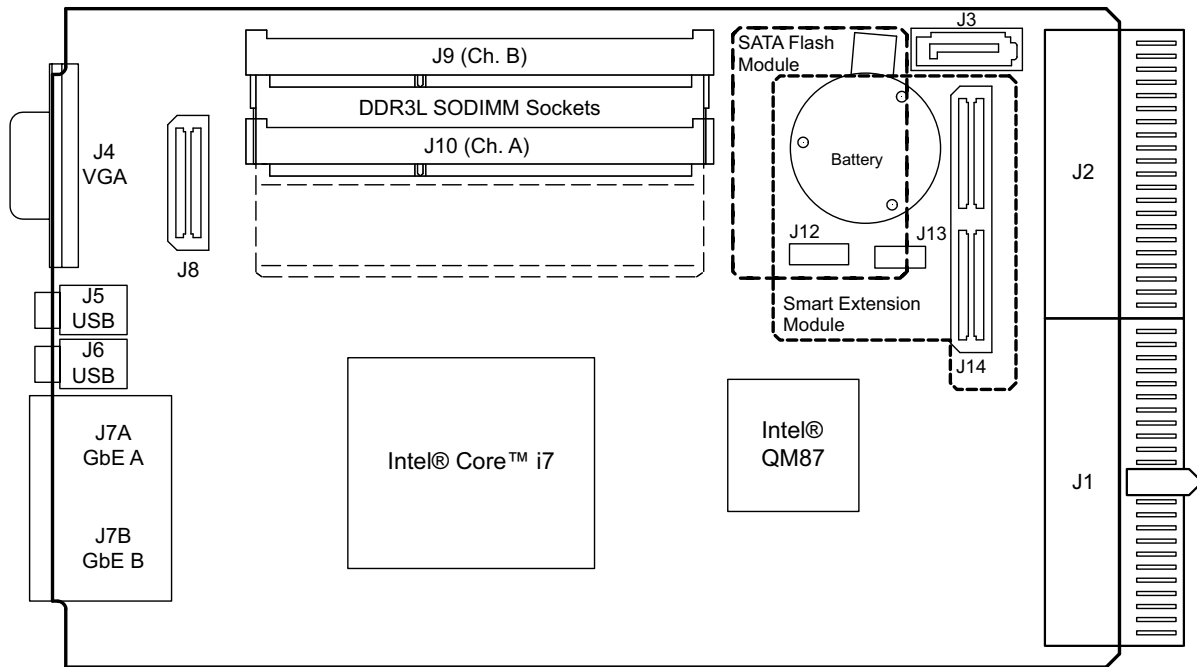
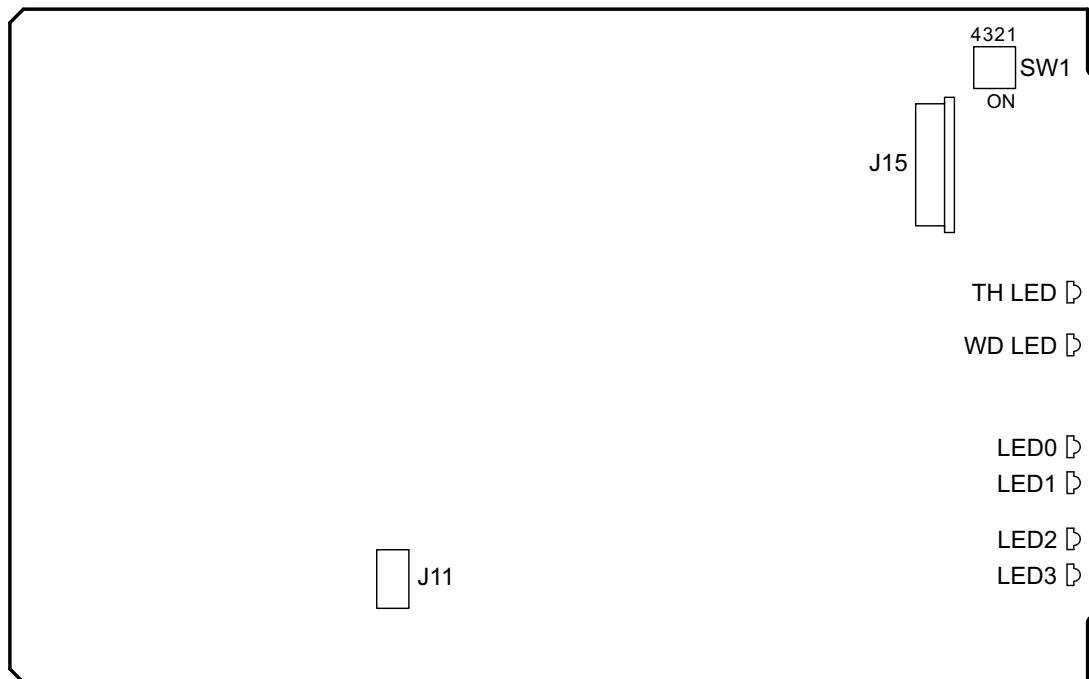

Figure 4: 4 HP CP3004-SA Board Layout (Bottom View)



1.4 Technical Specification

Table 1: CP3004-SA Main Specifications

FEATURES		SPECIFICATIONS
Processor & Chipset	CPU & Graphics Controller	The CP3004-SA supports the following 4 th and 5 th generation processors: <ul style="list-style-type: none"> » Quad-core Intel® Core™ i7-5700EQ, 2.6 GHz, 6 MB L3 cache, GT2, Intel® HD Graphics 5600 » Dual-core Intel® Core™ i5-4410E, 2.9 GHz, 3 MB L3 cache, GT2, Intel® HD Graphics 4600 » Dual-core Intel® Core™ i3-4112E, 1.8 GHz, 3 MB L3 cache, GT2, Intel® HD Graphics 4600
	PCH	Intel® QM87 Chipset
Memory	Main Memory	Up to 16 GB, dual-channel DDR3L SDRAM memory with ECC running at 1600 MT/s on two SODIMM sockets
	Flash Memory	Two 16 MB SPI boot flash chips for two separate uEFI BIOS images Up to 32 GB SLC NAND flash memory via an onboard SATA Flash module (SSD)
	EEPROM	EEPROM with 64 kbit
Interfaces	CompactPCI	Compliant with CompactPCI Specification PICMG® 2.0 R 3.0: <ul style="list-style-type: none"> » System master operation » 32-bit/33 MHz master interface (66 MHz on request) » 3.3 V or 5 V (universal PCI interface) » Support for up to seven peripheral slots (7x REQ/GNT signals) When installed in a peripheral slot, the CP3004-SA is isolated from the Compact-PCI bus. It receives power from the backplane and supports rear I/O. CP3004-SA insertion/removal under power: When installed in a peripheral slot, the CP3004-SA supports hot plugging on the power interface through a dedicated power controller, but not on the PCI interface. Hot swapping of peripheral boards controlled by the CP3004-SA: When installed in the system controller slot, the CP3004-SA supports the hot swapping of other boards. Individual clocks for each slot and ENUM signal handling are in compliance with the PICMG 2.1 Hot Swap Specification. The CP3004-SA itself, however, is not hot swappable. When installed in the system controller slot, the system must be powered down in order to replace the board.
	Rear I/O	The following interfaces are routed to the rear I/O connector J2: <ul style="list-style-type: none"> » COMA and COMB, or COMA and GPIO (all ports have 3.3V LVTTTL signaling) » 2 x USB 2.0 » VGA (analog) » 2x Gigabit Ethernet » 2x SATA 3Gb/s » System management signals » Input for 5V standby power » General purpose signals

Table 1: CP3004-SA Main Specifications (Continued)

FEATURES	SPECIFICATIONS
Gigabit Ethernet	<p>Two 10 Base-T/100 Base-TX/1000 Base-T Ethernet interfaces based on two Intel® I210-IT Ethernet controllers with PCI Express 2.1 (2.5GT/s) support, both interfaces individually switchable to front I/O or rear I/O:</p> <ul style="list-style-type: none"> » Dual RJ-45 connector on the front panel » Automatic mode recognition (Auto-Negotiation) » Automatic cabling configuration recognition (Auto-MDI/X) » Wake-on-LAN support available only on the two interfaces switchable to front I/O or rear I/O <p>In addition, one 10 Base-T/100 Base-TX/1000 Base-T Ethernet interface based on one Intel® 82574L controller is available with the CP3004-HDD module.</p>
USB	<p>Five USB ports supporting UHCI (USB 1.1), EHCI (USB 2.0) and XHCI (USB 3.0):</p> <ul style="list-style-type: none"> » Two USB 2.0 ports on the front I/O » Two USB 2.0 ports on the rear I/O interface » One USB 3.0 port on the CP3004-HDD module
Serial	<p>Two 16C550-compatible UARTs:</p> <ul style="list-style-type: none"> » COMA available on the 8 HP extension module or on rear I/O » COMB or GPIO available on rear I/O only
SATA	<ul style="list-style-type: none"> » Six SATA ports, two onboard, two on rear I/O, and two on the 8 HP extension module » Data transfer rates up to 600 MB/s » High-performance RAID 0/1/5/10 functionality on all SATA ports
I/O Expansion Interfaces	<p>I/O expansion to 8 HP board version via the CP3004-HDD module:</p> <ul style="list-style-type: none"> » SATA 6 Gb/s » CFast (SATA 3 Gb/s) » USB 3.0 » 2x DP (DisplayPort) » COMA » Reset button and HDD/SSD activity LED » 10 Base-T/100 Base-TX/1000 Base-T Ethernet (Intel® 82574L controller) <p>I/O expansion to 12 HP board version via the CP3004-HDD module and the 2.5" SATA adapter module:</p> <ul style="list-style-type: none"> » 2x SATA (SATA 3 Gb/s and SATA 6 Gb/s) » USB 3.0 » 2x DP (DisplayPort) » COMA » Reset button and HDD/SSD activity LED » 10 Base-T/100 Base-TX/1000 Base-T Ethernet (Intel® 82574L controller) <p>I/O expansion to 8 HP board version via the CP3004-XMC module:</p> <ul style="list-style-type: none"> » PCI Express x8, x4 or x1 » CFast (SATA 3 Gb/s) <p>I/O expansion of CP3004-SA via the Smart Extension Module (exceeds 4 HP):</p> <ul style="list-style-type: none"> » SATA 3 Gb/s » USB 2.0

Interfaces

Table 1: CP3004-SA Main Specifications (Continued)

FEATURES		SPECIFICATIONS
Sockets	Front Panel Connectors	<ul style="list-style-type: none"> » VGA: 15-pin D-Sub connector, J4 » USB: two 4-pin, type A connectors, J5 and J6 » Ethernet: dual RJ-45 connector, J7A/B
	Onboard Connectors	<ul style="list-style-type: none"> » 7-pin, L-form standard SATA connector, J3 » 120-pin, high-speed I/O extension connector, J14 » 60-pin, high-speed I/O extension connector, J8 » SPI extension connector, J11 » 18-pin extension connector for the SATA Flash module (SSD), J12 » JTAG connector, J13 » XDP-SFF (debug) connector, J15 » CompactPCI connectors J1 and J2 » Two 204-pin DDR3L SODIMM sockets, J9 and J10
LEDs	Front Panel LEDs	Watchdog and Overtemperature Status LEDs: <ul style="list-style-type: none"> » WD (green): Watchdog Status » TH (red/green): Overtemperature Status General Purpose LEDs: <ul style="list-style-type: none"> » LED0..3 (red/green/red+green): General Purpose/ POST Code Ethernet LEDs: <ul style="list-style-type: none"> » ACT (green): Network/ Link Activity » SPEED (green/orange): Network Speed
Switch	DIP Switch	One quad DIP switch, SW1, for board configuration
Timer	Real-Time Clock	Real-time clock with 256 Byte CMOS RAM; battery-backup available
	Watchdog Timer	Software-configurable, two-stage Watchdog with programmable timeout settings. The timeout values range from 125 ms to 4096 s. The Watchdog serves for generating an IRQ and/or a hardware reset.
	System Timer	The Intel® QM87 Chipset contains three 8254-style counters with fixed uses. In addition to the three 8254-style counters, the Intel® QM87 Chipset includes eight individual high-precision event timers that may be used by the operating system. They are implemented as a single counter each with its own comparator and value register.
Thermal	Thermal Management	CPU and board overtemperature protection is provided by: <ul style="list-style-type: none"> » Temperature sensors integrated in the 4th and 5th generation Intel® Core™ i7/i5/i3 processor: <ul style="list-style-type: none"> » Up to four temperature sensors for monitoring the processor cores, one sensor for each core » One temperature sensor for monitoring the graphics core » One temperature sensor for monitoring the package die temperature » One temperature sensor integrated in the Intel® QM87 Chipset for monitoring the chipset » Specially designed heat sink
Security	TPM	Trusted Platform Module (TPM) 1.2 for enhanced hardware- and software-based data and system security

Table 1: CP3004-SA Main Specifications (Continued)

FEATURES		SPECIFICATIONS
Software	uEFI BIOS	<p>AMI Aptio®V BIOS firmware based on the uEFI Specification and the Intel Platform Innovation Framework for EFI.</p> <ul style="list-style-type: none"> » LAN boot capability for diskless systems (standard PXE) » Fail-safe recovery in case of a damaged image » Non-volatile storage of setting in the SPI boot flash (the battery is only required for the RTC) » Compatibility Support Module (CSM) providing legacy BIOS compatibility based on AMI Aptio®V » Command shell for diagnostics and configuration » uEFI Shell commands executable from mass storage device in a pre-OS environment (open interface)
	Operating Systems	There are various operating system board support packages available for the CP3004-SA. For further information, please contact Kontron.
General	Power Consumption	See Chapter 4 for details.
	Temperature Range	<p>Operational: 0°C to +60°C Standard (depending on processor version and airflow in the system)</p> <p style="padding-left: 100px;">-40°C to +85°C Extended (with Intel® Core™ i3-4112E processor only; the performance may be lowered depending on the airflow in the system)</p> <p>Storage: -40°C to +85°C Without hard disk and without battery</p> <p>Note: When a battery is installed, refer to its operational specifications as this may limit the operating and storage temperature of the CP3004-SA (see section "Battery" below).</p> <p>Note: When additional components are installed, refer to their operational specifications as this will influence the operational and storage temperature of the CP3004-SA.</p>
	Battery	<p>3.0V lithium battery for RTC with battery socket</p> <p>Battery type: UL-recognized CR2025</p> <p>Temperature range:</p> <p>Operational (load): -20°C to +70°C typical (refer to the battery manufacturer's specifications for exact range)</p> <p>Storage (no load): -40°C to +70°C typical</p>
	Climatic Humidity	93% RH at 40 °C, non-condensing (acc. to IEC 60068-2-78)
	Dimensions	<p>100 mm x 160 mm</p> <p>3U, 4 HP, CompactPCI compliant form factor</p> <p>Note: If a Smart Extension Module is installed on the CP3004-SA, the board exceeds 4 HP.</p>
	Board Weight	321 grams (4 HP CP3004-SA with heat sink, front panel, two 8 GB SODIMM memory modules, and battery, but without extension modules such as the SATA Flash module or the Smart Extension Module)

Note: For a description of the additional interfaces available on the 8 HP board versions, refer to Chapter 6, CP3004-HDD Module, and Chapter 7, CP3004-XMC Module, respectively.

1.5 Standards

This product complies with the requirements of the following standards.

Table 2: Standards

TYPE	ASPECT	STANDARD	REMARKS
CE	Emission	EN55022, EN61000-6-3	For information about the PCI clock instructions, refer to section 2.7.8.1.
	Immunity	EN55024, EN61000-6-2	--
	Electrical Safety	EN60950-1	--
Mechanical	Mechanical Dimensions	IEEE 1101.10	--
Environmental	Climatic Humidity	IEC60068-2-78 (see note below)	--
	WEEE	Directive 2002/96/EC	Waste electrical and electronic equipment
	RoHS 2	Directive 2011/65/EU	Restriction of the use of certain hazardous substances in electrical and electronic equipment
	Vibration (Sinusoidal)	IEC60068-2-6	Test parameters: 10-300 (Hz) frequency range 5 (g) acceleration 1 (oct/min) sweep rate 10 cycles/axis 3 axes
	Single Shock	IEC60068-2-27	Test parameters: 30 (g) acceleration 9 (ms) shock duration half sine 3 number of shocks per direction (total: 18) 6 directions 5 (s) recovery time
	Bump Shock	IEC60068-2-29	Test parameters: 15 (g) acceleration 11 (ms) shock duration half sine 500 number of shocks per direction 6 directions 5 (s) recovery time

Note: Customers desiring to perform further environmental testing of the CP3004-SA must contact Kontron for assistance prior to performing any such testing.

Boards **without conformal coating** must not be exposed to a change of temperature which can lead to condensation, as it may cause irreversible damage especially when the board is powered up again.

Kontron does not accept any responsibility for damage to products resulting from destructive environmental testing.

1.6 Related Publications

The following publications contain information relating to this product.

Table 3: Related Publications

PRODUCT	PUBLICATION
CompactPCI Systems	CompactPCI Specification PICMG 2.0, Rev. 3.0 CompactPCI Hot Swap Specification PICMG 2.1 Rev. 2.0
SATA	Serial ATA Specification Revision 3.0
CFast	CFast Specification Revision 1.0
XMC	ANSI/VITA 42.0-200x XMC Switched Mezzanine Card Auxiliary Standard ANSI/VITA 42.3-2006 XMC PCI Express Protocol Layer Standard
DisplayPort	VESA DisplayPort Standard Version 1.2a
Platform Firmware	Unified Extensible Firmware Interface (UEFI) specification, version 2.4
All Kontron products	Product Safety and Implementation Guide, ID 1021-9142

2 Functional Description

2.1 Processor and Chipset

The CP3004-SA supports the Intel® Core™ i7-5700EQ, the Intel® Core™ i5-4410E, and the Intel® Core™ i3-4112E processors in combination with the mobile Intel® QM87 Express Chipset.

Table 4: Features of the Processors Supported on the CP3004-SA

FEATURE	Intel® Core™ i7-5700EQ 2.6 GHz	Intel® Core™ i5-4410E 2.9 GHz	Intel® Core™ i3-4112E 1.8 GHz
Processor Cores	four	two	two
Processor Base Frequency (HFM)	2.6 GHz	2.9 GHz	1.8 GHz
Maximum Turbo Frequency	3.4 GHz	--	--
L3 cache	6 MB	3 MB	3 MB
DDR3L Memory	up to 16 GB / 1600 MT/s	up to 16 GB / 1600 MT/s	up to 16 GB / 1600 MT/s
Graphics	Intel® HD Graphics 5600	Intel® HD Graphics 4600	Intel® HD Graphics 4600
Graphics Base Frequency	300 MHz	400 MHz	400 MHz
Graphics Max. Dynamic Frequency	1.0 GHz	1.0 GHz	900 MHz
Configurable Thermal Design Power	cTDP	--	--
Thermal Design Power	47 W (cTDP down 37W)	37 W	25 W

Note: The CP3004-SA with the Intel® Core™ i7-5700EQ processor supports only the cTDP-Down mode to 37 W.

For further information about the processors used on the CP3004-SA, please visit the Intel website. For further information concerning the suitability of other Intel processors for use with the CP3004-SA, please contact Kontron.

2.1.1 Integrated Processor Graphics Controller

The 4th and 5th gen. Intel® Core™ i7/i5/i3 processor includes a highly integrated processor graphics controller delivering high-performance 3D and 2D graphics capabilities. The integrated processor graphics controller has three independent display interfaces allowing for support of multiple display configurations and provides three digital ports capable of driving the following resolutions:

- » VGA with an LCD monitor: up to 1920 x 1200 pixels @ 60 Hz
- » DisplayPort: up to 3840 x 2160 pixels @ 60 Hz

Note: The CP3004-SA supports one VGA and up to two DisplayPort interfaces.

2.2 Memory

The CP3004-SA supports a dual-channel (72-bit) DDR3L SDRAM memory with Error Checking and Correcting (ECC) running at 1600 MT/s. It provides two 204-pin sockets for two DDR3L ECC SODIMM modules that support up to 16 GB total system memory. The maximum memory size per channel is 8 GB.

The available total memory configuration can be either 4 GB, 8 GB or 16 GB. However, when the internal processor graphics controller is enabled, the amount of memory available to applications is less than the total physical memory in the system. The chipset's Dynamic Video Memory Technology, for example, dynamically allocates the proper amount of system memory required by the operating system and the application.

Note: Only qualified DDR3L ECC SODIMM modules from Kontron are authorized for use with the CP3004-SA. Replacement of the SODIMM modules by the customer without authorization from Kontron will void the warranty.

2.3 Watchdog Timer

The CP3004-SA provides a Watchdog timer that is programmable for a timeout period ranging from 125 ms to 4096 s in 16 steps.

The Watchdog timer provides the following modes or operation:

- » Timer-only mode
- » Reset mode
- » Interrupt mode
- » Dual-stage mode

In dual-stage mode, a combination of both interrupt and reset is generated if the Watchdog is not serviced.

2.4 Battery

The CP3004-SA is provided with an UL-recognized CR2025, 3.0 V, "coin cell" lithium battery for the RTC. When a battery is installed, refer to the operational specifications of the battery as this determines the operating and storage temperature of the CP3004-SA.

2.5 Flash Memory

The CP3004-SA provides flash interfaces for the uEFI BIOS and the SATA Flash module.

2.5.1 SPI Boot Flash for uEFI BIOS

The CP3004-SA provides two 16 MB SPI boot flashes for two separate uEFI BIOS images, a standard SPI boot flash and a recovery SPI boot flash. The fail-over mechanism for the uEFI BIOS recovery can be controlled via the DIP switch SW1, switch 2.

Note: The uEFI BIOS code and settings are stored in the SPI boot flashes. Changes made to the uEFI BIOS settings are available only in the currently selected SPI boot flash. Thus, switching over to the other SPI boot flash may result in operation with different uEFI BIOS code and settings.

2.5.2 SATA Flash Module

The CP3004-SA supports up to 32 GB flash memory as an optional SATA Flash module. The SATA Flash module cannot be used in conjunction with the Smart Extension Module, the CP3004-HDD module or the CP3004-XMC module.

2.6 Trusted Platform Module 1.2

The CP3004-SA supports the Trusted Platform Module (TPM) 1.2. TPM1.2 is a security chip specifically designed to provide enhanced hardware- and software-based data and system security. It is based on the Atmel AT97SC3204 security controller and stores sensitive data such as encryption and signature keys, certificates, and passwords. Furthermore, it is able to withstand software attacks to protect the stored information.

2.7 Board Interfaces

2.7.1 Front Panel LEDs

The CP3004-SA provides two system status LEDs: one temperature status LED (TH LED) and one Watchdog status LED (WD LED). It also provides four General Purpose/POST code LEDs (LED3..0). Their functionality is described in the following sections and reflected in the registers mentioned in Chapter 3 Configuration.

2.7.1.1 System Status LEDs

Table 5: System Status LEDs Function

LED	COLOR	STATE	FUNCTION
TH LED	red/ green	Off	Power failure
		Green	Board in normal operation
		Red	CPU has reached maximum allowable operating temperature and the performance has been reduced
		Red blinks	CPU temperature above 125°C (CPU has been shut off) In this event, all General Purpose LEDs (LED3..0) are blinking red as well.
WD LED	red/ green	OFF	Watchdog inactive
		Green	Watchdog active, waiting to be triggered
		Red	Watchdog expired

Note: If the TH LED flashes red at regular intervals, it indicates that the processor junction temperature has reached a level beyond which permanent silicon damage may occur and the processor has been shut off. To turn to normal operation, the power must be switched off and then on again.

2.7.1.2 General Purpose LEDs

The General Purpose LEDs (LED3..0) are designed to indicate the boot-up POST code after which they are available to the application. If the LED3..0 are lit red during boot-up, a failure is indicated. In this event, please contact Kontron for further assistance.

Table 6: General Purpose LEDs Function

LED	COLOR	FUNCTION DURING BOOT-UP	FUNCTION DURING uEFI BIOS POST (if POST code config. is enabled)	FUNCTION AFTER BOOT-UP
LED3	red	Power failure	--	General Purpose or Port 80 Default: General Purpose
	green	--	uEFI BIOS POST bit 3 and bit 7	
	red+green	--	--	
LED2	red	CPU catastrophic error	CPU catastrophic error	General Purpose or Port 80 Default: General Purpose
	green	--	uEFI BIOS POST bit 2 and bit 6	
	red+green	--	--	
LED1	red	Hardware reset	--	General Purpose or Port 80 Default: General Purpose
	green	--	uEFI BIOS POST bit 1 and bit 5	
	red+green	--	--	
LED0	red	uEFI BIOS boot failure	--	General Purpose or Port 80 Default: General Purpose
	green	--	uEFI BIOS POST bit 0 and bit 4	
	red+green	--	--	

For further information regarding the configuration of the General Purpose LEDs, refer to section 3.3.14 LED Configuration Register, and section 3.3.15 LED Control Register.

Note: The bit allocation for Port 80 is the same as for the POST code.

How to Read the 8-Bit POST Code

Due to the fact that only 4 LEDs are available and 8 bits must be displayed, the POST code output is multiplexed on the General Purpose LEDs.

Table 7: POST Code Sequence

STATE	GENERAL PURPOSE LEDs
0	All LEDs are OFF; start of POST sequence
1	High nibble
2	Low nibble; state 2 is followed by state 0

The following is an example of the General Purpose LEDs' operation if the POST configuration is enabled (see also Table 8).

Table 8: POST Code Example

	LED3	LED2	LED1	LED0	RESULT
HIGH NIBBLE	off (0)	on (1)	off (0)	off (0)	0x4
LOW NIBBLE	off (0)	off (0)	off (0)	on (1)	0x1
POST CODE	0x41				

Note: Under normal operating conditions, the General Purpose LEDs should not remain lit during boot-up. They are intended to be used only for debugging purposes. In the event that a General Purpose LED lights up during boot-up and the CP3004-SA does not boot, please contact Kontron for further assistance.

2.7.2 USB Interfaces

The CP3004-SA provides five USB ports:

- » Two USB 2.0 ports on the front I/O
- » Two USB 2.0 ports on the CompactPCI rear I/O interface
- » One USB 3.0 port on the high-speed I/O extension connector, J14, for the CP3004-HDD extension module, or one USB 2.0 port on the same connector for the Smart Extension Module

Note: Boards with a USB 3.0 flash drive installed on the front panel USB 3.0 port have been found to slightly exceed the electromagnetic interference limits. If permanent USB 3.0 type external storage is required to be connected to the USB 3.0 port, it is recommended to use an external hard disk drive.

On the front panel, the CP3004-SA has two standard, type A, USB 2.0 connectors, J5 and J6.

2.7.3 VGA Interface

The CP3004-SA provides one standard VGA interface for connection to a monitor. The VGA interface is implemented as a standard HD15 VGA connector, J4, on the front panel.

2.7.4 Serial Ports

The CP3004-SA provides two serial ports:

- » COMA available either on the CompactPCI rear I/O connector (3.3V LVTTTL) or on the CP3004-HDD extension module
- » COMB on the CompactPCI rear I/O connector (3.3V LVTTTL)

COMA and COMB are fully compatible with the 16C550 controller and include a complete set of handshaking and modem control signals. The COMA and COMB ports provide maskable interrupt generation. The data transfer on the COM ports is up to 115.2 kbit/s.

2.7.5 Gigabit Ethernet

The CP3004-SA board includes two 10Base-T/100Base-TX/1000Base-T Ethernet ports based on two Intel® I210-IT Ethernet controllers (two onboard and one on the CP3004-HDD extension module). The controllers are connected to x1 PCI Express interfaces of the Intel® QM87 Express Chipset. Two Gigabit Ethernet interfaces are individually switchable between front I/O and rear I/O and provide Wake-on-LAN support. In addition, one 10 Base-T/100 Base-TX/1000 Base-T Ethernet interface based on one Intel® 82574L controller is available with the CP3004-HDD module.

Note: In order to use the Wake-on-LAN feature available only with the two Intel® I210-IT Ethernet controllers, the power supply must not be switched off or the +5V stand-by voltage on the rear I/O module must be available. The CP3004-SA does not turn off the main power supply after an operating system shutdown in order to support Wake-on-LAN.

Two of the Gigabit Ethernet interfaces are implemented as standard RJ-45 Ethernet connectors, J7A/B on the front panel.

2.7.6 SATA Interfaces

The CP3004-SA provides six SATA ports:

- » One SATA 6 Gb/s port on the onboard standard, 7-pin SATA connector, J3, for connection to SATA devices via cable
- » One SATA 3 Gb/s port implemented on the J12 connector for the SATA Flash module
- » One SATA 3 Gb/s port for the CFast memory card on the CP3004-HDD/CP3004-XMC extension module (8HP) or for the second 2.5" HDD/SSD on the CP3004-HDD extension module (12 HP)
- » One SATA 6 Gb/s port for the 2.5" HDD/SSD on the CP3004-HDD extension module (8 HP)
- » Two SATA 3 Gb/s ports on the CompactPCI rear I/O interface

All six SATA interfaces provide high-performance RAID 0/1/5/10 functionality.

2.7.7 Debug Interface

The CP3004-SA provides several onboard options for hardware and software debugging, such as:

- » Four bicolor general purpose LEDs (LEDO..3), which indicate hardware failures, uEFI BIOS POST codes and user-configurable outputs
- » One JTAG connector, J13, for programming the onboard logic
- » One XDP-SFF, processor JTAG connector, J15, for facilitating the debug and uEFI BIOS software development
- » Two USB2.0-based debug ports, J5 and J6, for facilitating the debug of the operating system and the device driver

2.7.8 CompactPCI Interface

The CP3004-SA supports a flexible CompactPCI interface with a hot plug power interface (no PCI hot swap). In the system slot the PCI interface is in transparent mode, and in the peripheral slot the CompactPCI interface is isolated so that it cannot communicate with the CompactPCI bus. This mode is known as "passive mode".

2.7.8.1 Board Functionality when Installed in System Slot

In a system slot, the CompactPCI interface is provided as 32-bit/33 MHz (66 MHz upon request) PCI interface. The CP3004-SA supports up to seven peripheral slots through a CompactPCI backplane.

Note: The PCI clock signals to unpopulated peripheral slots must be disabled by using the `kboardconfig uEFI Shell` command. This is essential to maintain conformity to the CE mark and the FCC EMI requirements. Please contact Kontron for further information.

Note: The CP3004-SA supports universal PCI V(I/O) signaling voltages with one common resistor configuration. For both 5V and 3.3 V PCI signaling voltages, 2.7 k Ω pull-up resistors are used.

2.7.8.2 Board Functionality when Installed in Peripheral Slot (Passive Mode)

In a peripheral slot, the board receives power but does not communicate on the CompactPCI bus; all CompactPCI signals are isolated.

2.7.8.3 Front / Rear I/O Configuration

The CP3004-SA is available in two versions:

- » CP3004-SA front I/O version
- » CP3004-SA rear I/O version

Please ensure that the correct version is stated on the order. If the CP3004-SA is ordered with rear I/O configuration, various I/O interfaces and signals are available via the CompactPCI connector J2, such as USB, SATA, GbE, VGA, COM, power and management signals. If the CP3004-SA is ordered with front I/O configuration, the I/O interfaces and signals mentioned above are isolated from the CompactPCI connector J2.

Note: The CP3004-SA front I/O version does not provide 64-bit CompactPCI terminations to the backplane via the CompactPCI connector J2. With regard to this aspect, the CP3004-SA differs from previous boards such as CP307 or CP308 where 64-bit CompactPCI terminations are provided.

2.7.8.4 Board Insertion / Replacement under Power

The following features are implemented on the CP3004-SA:

- » Power ramping
- » ENUM signal handling (hot swapping of peripheral boards)

Power ramping on the CP3004-SA provides the hot plug functionality on the power interface. The PCI interface does not support hot swap functionality. No microswitch, no blue LED, and no signal pre-charge are provided on the CP3004-SA.

The ENUM signal on the CP3004-SA allows for hot swapping of peripheral boards with hot swap capability when the CP3004-SA is installed in the system slot.

Note: The CP3004-SA itself is not hot swappable when inserted in a system slot. When inserted in a peripheral slot, the CP3004-SA is hot pluggable.

2.7.8.5 Power Ramping

On the CP3004-SA a special power controller is used to ramp up the onboard supply voltages. This is done to avoid transients on the +3.3V and +5V power supplies from the system. When the power supply is stable, the power controller generates an onboard reset to put the board into a defined state.

2.7.8.6 ENUM# Interrupt

If the board is operated in the system slot, the ENUM signal is an input.

2.7.9 CompactPCI Connectors J1 and J2

The CP3004-SA provides two CompactPCI connectors, J1 and J2, with the following functionality:

- » J1: 32-bit CompactPCI interface with PCI bus signals, arbitration, clock and power
- » J2: arbitration, clock and optionally rear I/O interface functionality

The CP3004-SA is designed for a CompactPCI bus architecture and the board is capable of driving up to seven CompactPCI slots with individual arbitration and clock signals.

The CompactPCI standard is electrically identical to the PCI local bus. However, these systems are enhanced to operate in rugged industrial environments and to support multiple slots.

2.7.9.1 CompactPCI Connector Keying

CompactPCI backplane connectors support guide lugs to ensure a correct polarized mating (3.3 V or 5 V V(I/O) coding).

The CP3004-SA supports universal (3.3 V and 5 V) PCI V(I/O) signaling voltages with one common termination resistor configuration. Therefore, the CP3004-SA can be inserted in both, 3.3 V and 5 V CompactPCI systems and provides itself no guide lug.

Figure 5: CPCI Connectors J1/J2

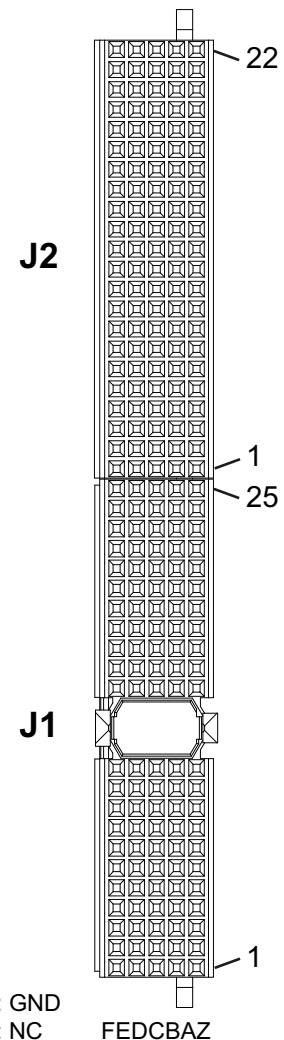

Note:
Pinrow F: GND
Pinrow Z: NC

FEDCBAZ

2.7.9.2 CompactPCI Connectors J1 and J2 Pinouts

The CP3004-SA is provided with two 2 mm x 2 mm pitch female CompactPCI bus connectors, J1 and J2.

Table 9: CompactPCI Connector J1 System Slot Pinout

PIN	Z	A	B	C	D	E	F
25	NC	5V	REQ64#	ENUM#	3.3V	5V	GND
24	NC	AD[1]	5V	V(I/O)	AD[0]	ACK64#	GND
23	NC	3.3V	AD[4]	AD[3]	5V	AD[2]	GND
22	NC	AD[7]	GND	3.3V	AD[6]	AD[5]	GND
21	NC	3.3V	AD[9]	AD[8]	M66EN	C/BE[0]#	GND
20	NC	AD[12]	GND	V(I/O)	AD[11]	AD[10]	GND
19	NC	3.3V	AD[15]	AD[14]	GND	AD[13]	GND
18	NC	SERR#	GND	3.3V	PAR	C/BE[1]#	GND
17	NC	3.3V	RSV	RSV	GND	PERR#	GND
16	NC	DEVSEL#	PCIXCAP	V(I/O)	STOP#	LOCK#	GND
15	NC	3.3V	FRAME#	IRDY#	BDSEL#	TRDY#	GND
12-14	Key Area						
11	NC	AD[18]	AD[17]	AD[16]	GND	C/BE[2]#	GND
10	NC	AD[21]	GND	3.3V	AD[20]	AD[19]	GND
9	NC	C/BE[3]#	NC	AD[23]	GND	AD[22]	GND
8	NC	AD[26]	GND	V(I/O)	AD[25]	AD[24]	GND
7	NC	AD[30]	AD[29]	AD[28]	GND	AD[27]	GND
6	NC	REQ0#	CPCI_PRESENT#	3.3V	CLK0	AD[31]	GND
5	NC	NC	NC	RST#	GND	GNT0#	GND
4	NC	NC	HEALTHY#	V(I/O)	RSV	RSV	GND
3	NC	INTA#	INTB#	INTC#	5V	INTD#	GND
2	NC	TCK	5V	TMS	NC	TDI	GND
1	NC	5V	-12 V	TRST#	12V	5V	GND

The legacy IDE interrupts INTP (CompactPCI specification pin D4) and INTS (CompactPCI specification pin E4) are not implemented on the CP3004-SA. Therefore, pins D4 and E4 are reserved.

The IPMB system management bus (CompactPCI specification pins A4, B17, C17) is not implemented on the CP3004-SA. Therefore, pin A4 is not connected and pins B17 and C17 are reserved.

For further information regarding the above-mentioned reserved pins, please contact Kontron.

Table 10: CompactPCI Connector J1 Peripheral Slot Pinout

PIN	Z	A	B	C	D	E	F
25	NC	5V	*	*	3.3V	5V	GND
24	NC	*	5V	V(I/O)	*	*	GND
23	NC	3.3V	*	*	5V	*	GND
22	NC	*	GND	3.3V	*	*	GND
21	NC	3.3V	*	*	*	*	GND
20	NC	*	GND	V(I/O)	*	*	GND
19	NC	3.3V	*	*	GND	*	GND
18	NC	*	GND	3.3V	*	*	GND
17	NC	3.3V	RSV	RSV	GND	*	GND
16	NC	*	*	V(I/O)	*	*	GND
15	NC	3.3V	*	*	BDSEL#	*	GND
14-12	Key Area						
11	NC	*	*	*	GND	*	GND
10	NC	*	GND	3.3V	*	*	GND
9	NC	*	NC	*	GND	*	GND
8	NC	*	GND	V(I/O)	*	*	GND
7	NC	*	*	*	GND	*	GND
6	NC	*	CPCI_PRESENT#	3.3V	*	*	GND
5	NC	NC	NC	RST#**	GND	*	GND
4	NC	NC	HEALTHY#	V(I/O)	RSV	RSV	GND
3	NC	*	*	*	5V	*	GND
2	NC	TCK	5V	TMS	NC	TDI	GND
1	NC	5V	-12 V	TRST#	12 V	5V	GND

Note: A * indicates that the signal normally present at this pin is disconnected from the CompactPCI bus when the CP3004-SA is inserted in a peripheral slot.

** When the CP3004-SA is inserted in a peripheral slot, the function of the RST# signal can be enabled or disabled.

Table 11: CompactPCI Connector J2 Pinout (CP3004-SA Front I/O Vers.)

PIN	Z	A	B	C	D	E	F
22	NC	GA4	GA3	GA2	GA1	GA0	GND
21	NC	CLK6	GND	RSV	RSV	RSV	GND
20	NC	CLK5	GND	RSV	RSV	RSV	GND
19	NC	GND	GND	RSV	RSV	RSV	GND
18	NC	RSV	RSV	RSV	RSV	RSV	GND
17	NC	RSV	RSV	PRST#	REQ6#	GNT6#	GND
16	NC	RSV	RSV	DEG#	GND	RSV	GND
15	NC	RSV	RSV	FAL#	REQ5#	GNT5#	GND
14	NC	RSV	RSV	RSV	RSV	RSV	GND
13	NC	RSV	RSV	RSV	RSV	RSV	GND
12	NC	RSV	RSV	RSV	RSV	RSV	GND
11	NC	RSV	RSV	RSV	RSV	RSV	GND
10	NC	RSV	RSV	RSV	RSV	RSV	GND
9	NC	RSV	GND	RSV	RSV	RSV	GND
8	NC	RSV	RSV	RSV	GND	RSV	GND
7	NC	RSV	RSV	RSV	RSV	RSV	GND
6	NC	RSV	RSV	RSV	GND	RSV	GND
5	NC	RSV	GND	RSV	RSV	RSV	GND
4	NC	V(I/O)	RSV	RSV	RSV	RSV	GND
3	NC	CLK4	GND	GNT3#	REQ4#	GNT4#	GND
2	NC	CLK2	CLK3	SYSEN#	GNT2#	REQ3#	GND
1	NC	CLK1	GND	REQ1#	GNT1#	REQ2#	GND

Note: The 64-bit CompactPCI signals are not used on the board and the 64-bit control and address signals are not terminated to V(I/O).

2.7.9.3 Optional Rear I/O Interface

The CP3004-SA board provides optional rear I/O connectivity for peripherals. When the rear I/O module is used, the signals of some of the main board/front panel connectors are routed to the rear I/O module interface.

The CP3004-SA with rear I/O is compatible with all standard 3U CompactPCI passive backplanes with rear I/O support.

Note: To support the rear I/O feature, a 3U CompactPCI backplane with rear I/O support is required. Do not plug a rear I/O configured board in a backplane without rear I/O support. Failure to comply with the above will result in damage to your board.

The CP3004-SA rear I/O provides the following interfaces (all signals are available on J2 only if the board is ordered with rear I/O functionality):

- » Two USB 2.0 ports
- » Two Gigabit Ethernet ports without LED signals
- » Two SATA ports
- » Two COM ports: COMA and COMB, or COMA and GPIO (all ports have 3.3V LVTTTL signaling)
- » General purpose (GPIO) signals: 5 x GPIs and 3 x GPOs
- » VGA analog port
- » Management and control signals
- » System write protection
- » Input for +5V standby power
- » Geographic addressing (GA[4..0] provided by the backplane)

Note: The pinout of the rear I/O CompactPCI connector on the CP3004-SA is compatible with that of the CP305, CP307, CP308, CP3002 and CP3003. Thus, rear I/O modules designed for these boards can also be used with the CP3004-SA.

Table 12: Rear I/O CompactPCI Connector J2 Pinout (CP3004-SA Rear I/O Vers.)

PIN	Z	A	B	C	D	E	F
22	NC	GA4	GA3	GA2	GA1	GA0	GND
21	NC	CLK6	GND	USBA+	USBB+	USBA_PWR_5V	GND
20	NC	CLK5	GND	USBA-	USBB-	USBB_PWR_5V	GND
19	NC	GND	GND	PWR_BTN#	PWR_SLPS3#	RIO_3.3V	GND
18	NC	COMA_RXD	COMA_DCD#	COMA_DTR#	GPI1/ COMB_CTS#	COMA_CTS#	GND
17	NC	COMA_TXD	GPI0/ COMB_RXD	PRST#	REQ6#	GNT6#	GND
16	NC	COMA_DSR#	COMA_RTS#	DEG#	GND	COMA_RI#	GND
15	NC	PWR_5VSTDBY	RIO_SYS_WP#	FAL#	REQ5#	GNT5#	GND
14	NC	IPA_DA+	IPA_DA-	GPO1/ COMB_RTS#	IPA_DC+	IPA_DC-	GND
13	NC	IPA_DB+	IPA_DB-	GPI4/ COMB_RI#	IPA_DD+	IPA_DD-	GND
12	NC	IPB_DA+	IPB_DA-	RIO_XFO_CT	IPB_DC+	IPB_DC-	GND
11	NC	IPB_DB+	IPB_DB-	GPI3/ COMB_DCD#	IPB_DD+	IPB_DD-	GND
10	NC	NC	GPO0/ COMB_TXD	VGA_RED	GPO2/ COMB_DTR#	NC	GND
9	NC	SATAATX+	GND	VGA_HSYNC	NC	SATABTX+	GND
8	NC	SATAATX-	NC	VGA_BLUE	GND	SATABTX-	GND
7	NC	NC	GPI2/ COMB_DSR#	VGA_DDC_DATA	RSV	NC	GND
6	NC	SATAARX+	NC	VGA_GREEN	GND	SATABRX+	GND
5	NC	SATAARX-	GND	VGA_VSYNC	NC	SATABRX-	GND
4	NC	V(I/O)	RIO_5V	VGA_DDC_CLK	GPIO_CFG0	NC	GND
3	NC	CLK4	GND	GNT3#	REQ4#	GNT4#	GND
2	NC	CLK2	CLK3	SYSEN#	GNT2#	REQ3#	GND
1	NC	CLK1	GND	REQ1#	GNT1#	REQ2#	GND

Note: The RIO_XXX signals are power supply **OUTPUTS** to supply the rear I/O module with power. These pins **MUST NOT** be connected to any other power source, either within the backplane itself or within a rear I/O module. Failure to comply with the above will result in damage to your board.

Table 13: CompactPCI Rear I/O Connector J2 Signals

SIGNAL	DESCRIPTION
COMAx	COMA port LVTTTL (3.3V)
COMBx	COMB port LVTTTL (3.3V)
GPI/GPO	General purpose input / general purpose output signal
GPIO_CFG0	GPIO or COMB configuration
IPx	Gigabit Ethernet copper port
SATAx	SATA port
USBx	USB interface and power
VGAx	VGA signal
RIO_XFO_CT	Power supply for Gigabit Ethernet transformer center tap
RIOx/V(I/O)	Power supply signal
PWRx	Power management signal
RSV	Reserved
GND	Ground signal
NC	Not connected

The GPIO_CFG0 signal on the rear I/O module enables the user to select between COMB and GPIO interfaces.

Table 14: GPIO Signal Description

SIGNAL	DESCRIPTION
GPIO_CFG0	0 = GPIO 1 = COMB

Note: The default value is 1 if pin D4 is not connected on the rear I/O module (pull-up resistor to 3.3V on CP3004-SA).

2.7.9.4 Rear I/O Pin Description

Serial Ports

The CP3004-SA provides two serial ports, COMA and COMB, both available on the rear I/O CompactPCI connector J2.

Table 15: COMA and COMB Signal Description

PIN on J2	SIGNAL	FUNCTION	DRIVEN BY	SIGNALING VOLTAGE
A17	COMA_TXD	TXD serial port (COMA)	CP3004-SA	LVTTTL (3.3V)
A18	COMA_RXD	RXD serial port (COMA)	Rear I/O module	LVTTTL (3.3V)
E18	COMA_CTS#	CTS signal serial port (COMA)	Rear I/O module	LVTTTL (3.3V)
B16	COMA_RTS#	RTS signal serial port (COMA)	CP3004-SA	LVTTTL (3.3V)
A16	COMA_DSR#	DSR signal serial port (COMA)	Rear I/O module	LVTTTL (3.3V)
B18	COMA_DCD#	DCD signal serial port (COMA)	Rear I/O module	LVTTTL (3.3V)
C18	COMA_DTR#	DTR signal serial port (COMA)	CP3004-SA	LVTTTL (3.3V)
E16	COMA_RI#	RI signal serial port (COMA)	Rear I/O module	LVTTTL (3.3V)
B10	COMB_TXD	TXD serial port (COMB)	CP3004-SA	LVTTTL (3.3V)
B17	COMB_RXD	RXD serial port (COMB)	Rear I/O module	LVTTTL (3.3V)
D18	COMB_CTS#	CTS signal serial port (COMB)	Rear I/O module	LVTTTL (3.3V)
C14	COMB_RTS#	RTS signal serial port (COMB)	CP3004-SA	LVTTTL (3.3V)
B7	COMB_DSR#	DSR signal serial port (COMB)	Rear I/O module	LVTTTL (3.3V)
C11	COMB_DCD#	DCD signal serial port (COMB)	Rear I/O module	LVTTTL (3.3V)
D10	COMB_DTR#	DTR signal serial port (COMB)	CP3004-SA	LVTTTL (3.3V)
C13	COMB_RI#	RI signal serial port (COMB)	Rear I/O module	LVTTTL (3.3V)

Note: The pins for the interfaces COMA and COMB (pins A18, A17, A16, B18, B17, B16, B10, B7, C18, C14, C13, C11, D18, D10, E18, and E16) tolerate only 3.3V signaling and their inputs (driven by the rear I/O module) have internal pull-up resistors.

General Purpose Inputs/Outputs

Alternatively, the following GPIO signals are available instead of the COMB signals if pin D4 on the rear I/O connector J2 (GPIO_CFG0) is set to 0.

Table 16: GPIO Signal Description

PIN on J2	SIGNAL	FUNCTION	DRIVEN BY	SIGNALING VOLTAGE
B10	GP00	General purpose output 0	CP3004-SA	LVTTTL (3.3V)
B17	GPIO	General purpose input 0	Rear I/O module	LVTTTL (3.3V)
D18	GPI1	General purpose input 1	Rear I/O module	LVTTTL (3.3V)
C14	GP01	General purpose output 1	CP3004-SA	LVTTTL (3.3V)
B7	GPI2	General purpose input 2	Rear I/O module	LVTTTL (3.3V)
C11	GPI3	General purpose input 3	Rear I/O module	LVTTTL (3.3V)
D10	GP02	General purpose output 2	CP3004-SA	LVTTTL (3.3V)
C13	GPI4	General purpose input 4	Rear I/O module	LVTTTL (3.3V)

Note: The pins for the GPIO interface (pins B17, B10, B7, C14, C13, C11, D18, and D10) tolerate only 3.3 V signaling and their inputs (driven by the rear I/O module) have internal pull-up resistors.

VGA Interface

VGA signals are available either on the front VGA connector, J4, or on the rear I/O interface due to the implemented switch on the CP3004-SA. Switching over from front to rear I/O or vice versa is effected using the uEFI BIOS.

Table 17: VGA Signal Description

PIN on J2	SIGNAL	FUNCTION	DRIVEN BY	SIGNALING VOLTAGE
C10	VGA_RED	VGA analog red signal	CP3004-SA	Analog
C6	VGA_GREEN	VGA analog green signal	CP3004-SA	Analog
C8	VGA_BLUE	VGA analog blue signal	CP3004-SA	Analog
C9	VGA_HSYNC	VGA horizontal synchronization signal	CP3004-SA	LVTTTL (3.3 V)
C5	VGA_VSYNC	VGA vertical synchronization signal	CP3004-SA	LVTTTL (3.3 V)
C4	VGA_DDC_CLK	Monitor control clock signal	CP3004-SA	TTL (5 V)
C7	VGA_DDC_DATA	Monitor control data signal	Bidirectional	TTL (5 V)

Note: On the rear I/O, the CP3004-SA provides 150 Ω termination resistors for the red, green and blue VGA signals. Thus, further 150 Ω termination resistors are necessary on the rear I/O module to reach the required 75 Ω termination for the VGA connection.

Ethernet Interfaces

Gigabit Ethernet signals are available either on the front RJ-45 connector or on the rear I/O interface due to the implemented switches on the CP3004-SA. Both Gigabit Ethernet channels are individually switchable to front or rear I/O. Switching over from front to rear I/O or vice versa is effected using the uEFI BIOS settings (default: front I/O).

Table 18: Gigabit Ethernet Signal Description

PIN on J2	SIGNAL	FUNCTION	DRIVEN BY	SIGNALING VOLTAGE
A14	IPA_DA+	Media-dependent interface port A	Bidirectional	Analog
B14	IPA_DA-	Media-dependent interface port A	Bidirectional	Analog
A13	IPA_DB+	Media-dependent interface port A	Bidirectional	Analog
B13	IPA_DB-	Media-dependent interface port A	Bidirectional	Analog
D14	IPA_DC+	Media-dependent interface port A	Bidirectional	Analog
E14	IPA_DC-	Media-dependent interface port A	Bidirectional	Analog
D13	IPA_DD+	Media-dependent interface port A	Bidirectional	Analog
E13	IPA_DD-	Media-dependent interface port A	Bidirectional	Analog
A12	IPB_DA+	Media-dependent interface port B	Bidirectional	Analog
B12	IPB_DA-	Media-dependent interface port B	Bidirectional	Analog
A11	IPB_DB+	Media-dependent interface port B	Bidirectional	Analog
B11	IPB_DB-	Media-dependent interface port B	Bidirectional	Analog
D12	IPB_DC+	Media-dependent interface port B	Bidirectional	Analog
E12	IPB_DC-	Media-dependent interface port B	Bidirectional	Analog
D11	IPB_DD+	Media-dependent interface port B	Bidirectional	Analog
E11	IPB_DD-	Media-dependent interface port B	Bidirectional	Analog
C12	RIO_XFO_CT	Power supply for transformer center tap	CP3004-SA	NC

Note: The Ethernet magnetics must be placed on the rear I/O module. The Ethernet transformer center tap must be connected to pin C12 on J2 (RIO_XFO_CT) if the rear I/O module should work with other Kontron CompactPCI products. The center tap of the transformer used for the Intel® I210-IT Ethernet controller does not need a dedicated power supply.

SATA Interfaces

The CP3004-SA provides two SATA interfaces on the rear I/O CompactPCI connector J2.

Table 19: SATA Signal Description

PIN on J2	SIGNAL	FUNCTION	DRIVEN BY	SIGNALING VOLTAGE
A6	SATAARX+	Positive input port A	Rear I/O module	Differential
A5	SATAARX-	Negative input port A	Rear I/O module	Differential
A9	SATAATX+	Positive output port A	CP3004-SA	Differential
A8	SATAATX-	Negative output port A	CP3004-SA	Differential
E6	SATABRX+	Positive input port B	Rear I/O module	Differential
E5	SATABRX-	Negative input port B	Rear I/O module	Differential
E9	SATABTX+	Positive output port B	CP3004-SA	Differential
E8	SATABTX-	Negative output port B	CP3004-SA	Differential

USB Interfaces

Two USB 2.0 ports are available on the rear I/O CompactPCI connector J2.

Table 20: USB Signal Description

PIN on J2	SIGNAL	FUNCTION	DRIVEN BY	SIGNALING VOLTAGE
C21	USBA+	Positive USB port A	Bidirectional	Differential
C20	USBA-	Negative USB port A	Bidirectional	Differential
E21	USBA_PWR_5V	USB power supply 5 V port A	CP3004-SA	5 V (current limited)
D21	USBB+	Positive USB port B	Bidirectional	Differential
D20	USBB-	Negative USB port B	Bidirectional	Differential
E20	USBB_PWR_5V	USB power supply 5 V port B	CP3004-SA	5 V (current limited)

Power Supply and Power Management Signals

The CP3004-SA provides the following power supply and power management signals to the rear I/O module.

Table 21: Power Supply and Power Management Signal Description

PIN on J2	SIGNAL	FUNCTION	DRIVEN BY	SIGNALING VOLTAGE
B4	RIO_5V	Power supply 5 V	CP3004-SA	5 V
E19	RIO_3.3V	Power supply 3.3 V	CP3004-SA	3.3 V
A4	V(I/O)	Power supply V(I/O)	Backplane	5 V or 3.3 V
A15	PWR_5V_STDBY	Power supply 5 V standby	Rear I/O module	5 V
C19	PWR_BTN#	Power button signal	Rear I/O module	Open drain (pull-up resistor on the CP3004-SA) or LVTTTL (3.3 V)
D19	PWR_SLPS3#	Sleep S3 signal	CP3004-SA	LVTTTL (3.3 V)
D7	RSV	Reserved	--	--
B15	RIO_SYS_WP#	System write protection	Rear I/O module	LVTTTL (3.3V)

Note: Pin D7 **MUST NOT** be connected to any signal, either within the backplane itself or within a rear I/O module. Failure to comply with the above will result in damage to your board.

Note: Pins B4 and E19 are power supply **OUTPUTS** to supply the rear I/O module with power. These pins **MUST NOT** be connected to any other power source, either within the backplane itself or within a rear I/O module. Failure to comply with the above will result in damage to your board.

For further information regarding the rear I/O signals, please contact Kontron.

3 Configuration

3.1 DIP Switch Configuration

The quad DIP switch SW1 provides the following switches for board configuration: POST code indication, SPI boot flash selection, and uEFI BIOS configuration.

Figure 6: DIP Switch SW1

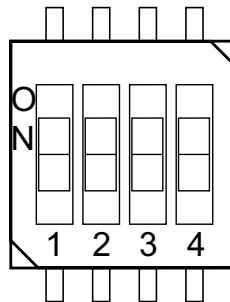

Table 22: DIP Switch SW1 Functionality

SWITCH	SETTING	FUNCTIONALITY
1	<i>OFF</i>	<i>Boot-up with POST code indication on LED3..0</i>
	ON	Boot-up without POST code indication on LED3..0
2	<i>OFF</i>	<i>Boot from the standard SPI boot flash</i>
	ON	Boot from the recovery SPI boot flash
3	<i>OFF</i>	<i>Standard QM87 reset implementation</i>
	ON	Reset does a power cycle (reset event deasserts the QM87 PWROK input)
4	<i>OFF</i>	<i>Boot using the currently saved uEFI BIOS settings</i>
	ON	Clear the uEFI BIOS settings and use the default values

The default setting is indicated by using italic bold.

To clear the uEFI BIOS settings and the passwords, proceed as follows:

1. Set DIP switch SW1, switch 4, to the ON position.
2. Apply power to the system.
3. Wait 30 seconds and then remove power from the system. During this time period no messages are displayed.
4. Set DIP switch SW1, switch 4, to the OFF position.

3.2 System Write Protection

The CP3004-SA provides write protection for non-volatile memories via the onboard configuration resistors JMP2 (only available upon request), the uEFI Shell and the CompactPCI rear I/O connector J2, pin B15 (RIO_SYS_WP#). If one of these sources is enabled, the system is write protected. Please contact Kontron for further information before using these functions.

3.3 CP3004-SA-Specific Registers

Table 23: CP3004-SA-Specific Registers

ADDRESS	DEVICE
0x280	Status Register 0 (STAT0)
0x281	Status Register 1 (STAT1)
0x282	Control Register 0 (CTRL0)
0x283	Control Register 1 (CTRL1)
0x284	Write Protection Register (WPROT)
0x285	Reset Status Register (RSTAT)
0x286	Board Interrupt Configuration Register (BICFG)
0x287	Status Register 2 (STAT2)
0x288	Board ID High-Byte Register (BIDH)
0x289	Board and PLD Revision Register (BREV)
0x28A	Geographic Addressing Register (GEOAD)
0x28C	Watchdog Timer Control Register (WTIM)
0x28D	Board ID Low-Byte Register (BIDL)
0x290	LED Configuration Register (LCFG)
0x291	LED Control Register (LCTRL)
0x292	General Purpose Output Register (GPOUT)
0x293	General Purpose Input Register (GPIN)

3.3.1 Status Register 0 (STAT0)

The Status Register 0 holds general/common status information.

Table 24: Status Register 0 (STAT0)

ADDRESS	0x280							
BIT	7	6	5	4	3	2	1	0
NAME	Reserved	BBEI	BFSS		DIP4	DIP3	DIP2	DIP1
ACCESS	R	R	R		R	R	R	R
RESET	0	0	N/A		N/A	N/A	N/A	N/A
BITFIELD		DESCRIPTION						
6	BBEI	uEFI BIOS boot end indication: 0 = uEFI BIOS is booting 1 = uEFI BIOS boot is finished						
5 - 4	BFSS	SPI boot flash selection status: 00 = Standard SPI boot flash active 01 = Recovery SPI boot flash active 10 = External SPI boot flash active 11 = Reserved						
3	DIP4	DIP switch SW1, switch 4 (clear the uEFI BIOS settings): 0 = Switch on (clear the uEFI BIOS settings) 1 = Switch off (boot using the currently saved uEFI BIOS settings)						
2	DIP3	DIP switch SW1, switch 3 (reset configuration): 0 = Switch on (reset does a power cycle) 1 = Switch off (standard reset configuration)						
1	DIP2	DIP switch SW1, switch 2 (select SPI flash): 0 = Switch on (boot from recovery SPI boot flash) 1 = Switch off (boot from standard SPI boot flash)						
0	DIP1	DIP switch SW1, switch 1 (POST code indication on LED0..3): 0 = Switch on (boot-up without POST code indication on LED0..3) 1 = Switch off (boot-up with POST code indication on LED0..3)						

3.3.2 Status Register 1 (STAT1)

The Status Register 1 holds board-specific status information.

Table 25: Status Register 1 (STAT1)

ADDRESS	0x281							
BIT	7	6	5	4	3	2	1	0
NAME	C66EN	Reserved			CSYS	CENUM	CFAL	CDEG
ACCESS	R	R			R	R	R	R
RESET	N/A	000			N/A	N/A	N/A	N/A
BITFIELD		DESCRIPTION						
7	C66EN	CPCI PCI speed (M66EN signal): 0 = 33 MHz 1 = 66 MHz						
3	CSYS	CPCI system slot identification (SYSEN signal): 0 = Installed in a system slot 1 = Installed in a peripheral slot						
2	CENUM	CPCI system enumeration (ENUM signal): 0 = Indicates the insertion or removal of a hot swap peripheral board when the CP3004-SA operates as the system controller board 1 = No hot swap event						
1	CFAL	CPCI power supply status (FAL signal): 0 = Power supply failure 1 = Power in normal state						
0	CDEG	CPCI power supply status (DEG signal): 0 = Power derating 1 = Power in normal state						

3.3.3 Control Register 0 (CTRL0)

The Control Register 0 holds a series of bits defining general/common configuration functions.

Table 26: Control Register 0 (CTRL0)

ADDRESS	0x282							
BIT	7	6	5	4	3	2	1	0
NAME	VGAM		BFUS	Reserved				
ACCESS	R/W		R/W	R				
RESET	01		0	00000				
BITFIELD		DESCRIPTION						
7 - 6	VGAM	VGA mode configuration: 00 = Automatic VGA front detection 01 = Front VGA (uEFI BIOS default) 10 = Rear VGA 11 = VGA disabled						
5	BFUS	SPI boot flash selection: 0 = Select the standard SPI boot flash for update 1 = Select the recovery SPI boot flash for update						

3.3.4 Control Register 1 (CTRL1)

The Control Register 1 holds board-specific control information.

Table 27: Control Register 1 (CTRL1)

ADDRESS	0x283								
BIT	7	6	5	4	3	2	1	0	
NAME	SRST	VRST	TRST	CRST	Reserved	SCOMA	Reserved		
ACCESS	R/W	R	R/W	R/W	R	R/W	R		
RESET	1	1	1	0	0	N/A	00		
BITFIELD		DESCRIPTION							
7	SRST	SATA Flash module configuration: 0 = Reset of SATA Flash module 1 = SATA Flash module running							
6	VRST	Integrated processor graphics controller configuration: 0 = Processor graphics controller disabled 1 = Processor graphics controller enabled							
5	TRST	Trusted Platform Module (TPM) configuration: 0 = TPM disabled 1 = TPM enabled							
4	CRST	CPCI reset input when the CP3004-SA is in a peripheral slot: 0 = Disable CPCI reset to board 1 = Enable CPCI reset to board							
2	SCOMA	COMA routing selection: 0 = Rear I/O 1 = Extension module							

Note: The reset value of the SCOMA bit depends on the board version ordered. If the CP3004-SA is ordered as a rear I/O version, the reset value is 0. If the CP3004-SA is ordered as a front I/O version, an automatic switch over to the 8 HP extension module is processed per default.

3.3.5 Device Protection Register (DPROT)

The Device Protection Register holds the write protect signals for non-volatile devices.

Table 28: Device Protection Register (DPROT)

ADDRESS	0x284							
BIT	7	6	5	4	3	2	1	0
NAME	SWP	Reserved			SFWP	JMP2	BSWP	SSWP
ACCESS	R	R			R/W	R	R	R/W
RESET	0	000			0	0	0	0
BITFIELD		DESCRIPTION						
7	SWP	System write protection status: 0 = Onboard non-volatile memory devices not write protected 1 = Onboard non-volatile memory devices write protected						
3	SFWP	SATA Flash module write protection status: 0 = SATA Flash module write protection included in system write protection 1 = SATA Flash module write protection not included in system write protection This bit is read-only if the system write protection bit is activated (SWP = '1').						
2	JMP2	System write protection via configuration resistors JMP2: 0 = System not write protected via JMP2 1 = System write protected via JMP2						
1	BSWP	System write protection via backplane (SYS_WP#): 0 = System not write protected via backplane 1 = System write protected via backplane						
0	SSWP	System write protection via software: 0 = System devices not write protected via software 1 = System write protected via software Writing a '1' to this bit clears it. If this bit is set, it cannot be cleared.						

3.3.6 Reset Status Register (RSTAT)

The Reset Status Register is used to determine the host's reset source.

Table 29: Reset Status Register (RSTAT)

ADDRESS	0x285								
BIT	7	6	5	4	3	2	1	0	
NAME	PORS	Reserved				FPRS	CPRS	WTRS	
ACCESS	R/W	R				R/W	R/W	R/W	
RESET	N/A	0000				0	0	0	
BITFIELD		DESCRIPTION							
7	PORS	Power-on reset status: 0 = System reset generated by warm reset 1 = System reset generated by power-on (cold) reset Writing a '1' to this bit clears it.							
2	FPRS	Front panel push button reset status (CP3004-HDD/CP3004-XMC): 0 = System reset not generated by front panel reset 1 = System reset generated by front panel reset Writing a '1' to this bit clears it.							
1	CPRS	CompactPCI reset status (PRST signal): 0 = System reset not generated by CompactPCI reset input 1 = System reset generated by CompactPCI reset input Writing a '1' to this bit clears it.							
0	WTRS	Watchdog timer reset status: 0 = System reset not generated by Watchdog timer 1 = System reset generated by Watchdog timer Writing a '1' to this bit clears it.							

Note: The Reset Status Register is set to default values by power-on (cold) reset, not by a warm reset.

3.3.7 Board Interrupt Configuration Register (BICFG)

The Board Interrupt Configuration Register holds a series of bits defining the interrupt routing.

Table 30: Board Interrupt Configuration Register (BICFG)

ADDRESS	0x286								
BIT	7	6	5	4	3	2	1	0	
NAME	UICF	CFICF	CEICF	CDICF	Reserved		WICF		
ACCESS	R/W	R/W	R/W	R/W	R		R/W		
RESET	1	0	0	0	00		00		
BITFIELD		DESCRIPTION							
7	UICF	UART IRQ3 and IRQ4 interrupt configuration: 0 = IRQ3 and IRQ4 interrupt disabled 1 = IRQ3 and IRQ4 interrupt enabled							
6	CFICF	CPCI fail signal interrupt configuration (FAL signal): 0 = IRQ5 disabled 1 = IRQ5 enabled							
5	CEICF	CPCI enumeration signal interrupt configuration (ENUM signal): 0 = IRQ5 disabled 1 = IRQ5 enabled							
4	CDICF	CPCI derate signal interrupt configuration (DEG signal): 0 = IRQ5 disabled 1 = IRQ5 enabled							
1 - 0	WICF	Watchdog interrupt configuration: 00 = Disabled 01 = IRQ5 10 = Reserved 11 = Reserved							

3.3.8 Status Register 2 (STAT2)

The Status Register 2 holds status information related to the rear I/O configuration.

Table 31: Status Register 2 (STAT2)

ADDRESS	0x287							
BIT	7	6	5	4	3	2	1	0
NAME	Reserved		RCFG		MEZC			
ACCESS	R		R		R			
RESET	00		N/A*		N/A*			
BITFIELD		DESCRIPTION						
5 - 4	RCFG	Rear I/O configuration: 00 = Rear I/O disabled (CP3004-SA front I/O version) 01 = COMA, GPIO 10 = Reserved 11 = COMA, COMB						
3 - 0	MEZC	Mezzanine configuration: 0000 = None / Smart Extension Module 0001 = CP3004-XMC extension module 0010 = CP3004-HDD extension module 0011...FFFF = Reserved						

* The default value depends on the CP3004-SA version ordered (front I/O or rear I/O) and the rear I/O module used.

3.3.9 Board ID High-Byte Register (BIDH)

Table 32: Board ID High-Byte Register (BIDH)

ADDRESS	0x288							
BIT	7	6	5	4	3	2	1	0
NAME	BIDH							
ACCESS	R							
RESET	0xB4							
BITFIELD		DESCRIPTION						
7 - 0	BIDH	Board identification: CP3004-SA: 0xB430						

Note: The Board ID Low Byte Register is located at the address 0x28D.

3.3.10 Board and PLD Revision Register (BREV)

The Board and PLD Revision Register signals to the software when differences in the board and the Programmable Logic Device (PLD) require different handling by the software. It starts with the value 0x00 and will be incremented with each necessary change.

Table 33: Board and PLD Revision Register (BREV)

ADDRESS	0x289							
BIT	7	6	5	4	3	2	1	0
NAME	BREV				PREV			
ACCESS	R				R			
RESET	N/A				N/A			
BITFIELD		DESCRIPTION						
7 - 4	BREV	Board revision						
3 - 0	PREV	PLD revision						

3.3.11 Geographic Addressing Register (GEOAD)

The Geographic Addressing Register holds the CompactPCI geographic address (backplane-unique physical slot number).

Table 34: Geographic Addressing Register (GEOAD)

ADDRESS	0x28A							
BIT	7	6	5	4	3	2	1	0
NAME	Reserved				GA			
ACCESS	R				R			
RESET	000				N/A			
BITFIELD		DESCRIPTION						
7 - 5	Res.	Reserved						
4 - 0	GA	Geographic address						

3.3.12 Watchdog Timer Control Register (WTIM)

Table 35: Watchdog Timer Control Register (WTIM)

ADDRESS	0x28C							
BIT	7	6	5	4	3	2	1	0
NAME	WTE	WMD		WEN/WTR	WTM			
ACCESS	R/W	R/W		R/W	R/W			
RESET	0	00		0	0000			
BITFIELD		DESCRIPTION						
7	WTE	Watchdog timer expired status bit: 0 = Watchdog timer has not expired 1 = Watchdog timer has expired. Writing a '1' to this bit resets it to 0.						
6 - 5	WMD	Watchdog mode: 00 = Timer mode 01 = Reset mode 10 = Interrupt mode 11 = Cascaded mode (dual-stage mode)						
4	WEN/WTR	Watchdog enable/Watchdog trigger control bit: 0 = Watchdog timer not enabled Prior to the Watchdog being enabled, this bit is known as WEN. After the Watchdog is enabled, it is known as WTR. Once the Watchdog timer has been enabled, this bit cannot be reset to 0. As long as the Watchdog timer is enabled, it will indicate a '1'. 1 = Watchdog timer enabled Writing a '1' to this bit causes the Watchdog to be retrigged to the timer value indicated by WTM.						
3 - 0	WTM	Watchdog timeout settings: 0000 = 0.125 s 1000 = 32 s 0001 = 0.25 s 1001 = 64 s 0010 = 0.5 s 1010 = 128 s 0011 = 1 s 1011 = 256 s 0100 = 2 s 1100 = 512 s 0101 = 4 s 1101 = 1024 s 0110 = 8 s 1110 = 2048 s 0111 = 16 s 1111 = 4096 s						

The CP3004-SA has one Watchdog timer function with a programmable timeout ranging from 125 milliseconds to 4096 seconds. Failure to strobe the Watchdog timer within the programmed timeout delay results in a system reset or an interrupt.

There are four possible modes of operation:

- » Timer mode
- » Reset mode
- » Interrupt mode
- » Dual-stage mode

After the initial CP3004-SA power-on, the Watchdog is not enabled. To operate the Watchdog, the mode and timeout period required must first be set and then the Watchdog enabled. Once enabled, the Watchdog can only be disabled or the mode changed by powering down and then up again. To prevent a Watchdog timeout, the Watchdog must be retriggered before timing out. This is done by writing a '1' to the WTR bit. In the event a Watchdog timeout does occur, the WTE bit is set to '1'. What happens after this depends on the mode selected. The four operational Watchdog timer modes can be configured by the WMD[1:0] bits, and are described as follows:

Timer mode

In this mode the Watchdog is enabled using the required timeout period. Normally, the Watchdog is retriggered by writing a '1' to the WTR bit. In the event a timeout occurs, the WTE bit is set to '1'. This bit can be polled by the application and handled accordingly. Once a Watchdog timeout occurs, the Watchdog is deactivated (WEN bit gets reset to '0'). To continue using the Watchdog, write a '1' to the WTE bit to reset it, and then restart the Watchdog using WEN.

Reset mode

This mode is used to force a hard reset in the event of a Watchdog timeout. In addition, the WTE bit is not reset by the hard reset, which makes it available, if necessary, to determine the status of the Watchdog prior to the reset.

Interrupt mode

This mode generates an interrupt if a Watchdog timeout occurs. Configure the Watchdog interrupt in the Board Interrupt Configuration Register (0x286), otherwise no interrupt will be generated. The interrupt handling is a function of the application. If required, the WTE bit can be used to determine if a Watchdog timeout has occurred. Once a Watchdog timeout occurs, the Watchdog is deactivated (WEN bit gets reset to '0').

Dual-stage mode

This is a complex mode where in the event of a timeout two things occur:

1. an interrupt is generated, and
2. the Watchdog is retriggered automatically.

In the event a second timeout occurs immediately following the first timeout, a hard reset will be generated. If the Watchdog is retriggered normally, operation continues. The interrupt generated at the first timeout is available to the application to handle the first timeout if required. As with all of the other modes, the WTE bit is available for application use. Configure the Watchdog interrupt in the Board Interrupt Configuration Register (0x286), otherwise no interrupt will be generated.

3.3.13 Board ID Low-Byte Register (BIDL)

Table 36: Board ID Low-Byte Register (BIDL)

ADDRESS	0x28D							
BIT	7	6	5	4	3	2	1	0
NAME	BIDL							
ACCESS	R							
RESET	0x30							
BITFIELD		DESCRIPTION						
7 - 0	BIDL	Board identification: CP3004-SA: 0xB430						

Note: The Board ID High Byte Register is located at the address 0x288.

3.3.14 LED Configuration Register (LCFG)

The LED Configuration Register holds a series of bits defining the onboard configuration for the front panel General Purpose LEDs.

Table 37: LED Configuration Register (LCFG)

ADDRESS	0x290							
BIT	7	6	5	4	3	2	1	0
NAME	Reserved				LCON			
ACCESS	R				R/W			
RESET	0000				0000			
BITFIELD		DESCRIPTION						
3 - 0	LCON	LED3..0 configuration: 0000 = POST Mode (LEDs build a binary vector to display the Port 80 value) 0001 = General Purpose Mode (LEDs are controlled via the LCTRL register) 0010 - 1111 = Reserved						

Beside the configurable functions described above, LED3..0 fulfill also a basic debug function during the power-up phase as long as the first access to Port 80 is processed. For further information on reading the 8-bit uEFI BIOS POST Code, refer to section 2.7.1.2 General Purpose LEDs.

3.3.15 LED Control Register (LCTRL)

The LED Control Register enables the user to switch on and off the front panel General Purpose LEDs.

Table 38: LED Control Register (LCTRL)

ADDRESS	0x291							
BIT	7	6	5	4	3	2	1	0
NAME	LCMD				LCOL			
ACCESS	R/W				R/W			
RESET	0000				0000			
BITFIELD		DESCRIPTION						
7 - 4	LCMD	LED command: 0000 = Get LED0 1000 = Set LED0 0001 = Get LED1 1001 = Set LED1 0010 = Get LED2 1010 = Set LED2 0011 = Get LED3 1011 = Set LED3 0100 - 0111 = Reserved 1100 - 1111 = Reserved						
3 - 0	LCOL	LED color: 0000 = Off 0001 = Green 0010 = Red 0011 = Red+Green 0100 - 1111 = Reserved						

Note: The LED Control Register can only be used if the General Purpose LEDs indicated in the “LED Configuration Register” (see Table 38) are configured in General Purpose Mode. The status of certain LEDs can be obtained by writing a “Get LEDX” command where “x” is the LED number (color bits are ignored) followed by a simple read.

3.3.16 General Purpose Output Register (GPOUT)

The General Purpose Output Register holds the general purpose output signals of the rear I/O CompactPCI connector J2. This register can only be used if the CP3004-SA is ordered as a rear I/O version and the rear I/O GPIO operation is configured through the dedicated rear transition module configuration signal on the CompactPCI connector J2.

Table 39: General Purpose Output Register (GPOUT)

ADDRESS	0x292								
BIT	7	6	5	4	3	2	1	0	
NAME	Reserved					GPO2	GPO1	GPO0	
ACCESS	R					R/W	R/W	R/W	
RESET	00000					0	0	0	
BITFIELD		DESCRIPTION							
2 - 0	GPO2..0	General purpose output signals (3.3V LVTTTL): 0 = Output low 1 = Output high							

3.3.17 General Purpose Input Register (GPIN)

The General Purpose Input Register holds the general purpose input signals of the rear I/O CompactPCI connector J2. This register can only be used if the CP3004-SA is ordered as a rear I/O version and the rear I/O GPIO operation is configured through the dedicated rear transition module configuration signal on the CompactPCI connector J2.

Table 40: General Purpose Input Register (GPIN)

ADDRESS	0x293								
BIT	7	6	5	4	3	2	1	0	
NAME	Reserved			GPI4	GPI3	GPI2	GPI1	GPI0	
ACCESS	R			R	R	R	R	R	
RESET	000			1	1	1	1	1	
BITFIELD		DESCRIPTION							
4 - 0	GPI4..0	General purpose input signals (3.3V LVTTTL): 0 = Input low 1 = Input high							

Note: The CP3004-SA provides pull-up resistors on the rear I/O signal pins GPI[4..0], which leads to the default setting “input high” if the inputs are not connected.
The general purpose inputs support 3.3V LVTTTL signaling only (not 5V-tolerant).

4 Power Considerations

4.1 CP3004-SA Voltage Ranges

The CP3004-SA has been designed for optimal power input and distribution. Still it is necessary to observe certain criteria essential for application stability and reliability.

The system power supply must comply with the CompactPCI® specification.

The following table specifies the ranges for the input power voltage within which the board is functional.

Table 41: DC Operational Input Voltage Range

INPUT SUPPLY VOLTAGE	ABSOLUTE RANGE	RECOMMENDED RANGE
+3.3 V	3.2 V min. to 3.47 V max.	3.3 V min. to 3.47 V max.
+5 V	4.85 V min. to 5.25 V max.	5.0 V min. to 5.25 V max.
+5 V STDBY (optional)	4.85 V min. to 5.25 V max.	5.0 V min. to 5.25 V max.

Note: Failure to comply with the instructions above may result in damage to the board or improper operation.

4.2 Power Consumption of the CP3004-SA

The goal of this description is to provide a method to calculate the power consumption for the CP3004-SA baseboard and for additional configurations. The processor and the memory dissipate the majority of the thermal power.

The power consumption measurements were carried out using the following testing parameters:

- » CP3004-SA installed in the system slot of a Kontron 2-slot backplane with a CPA250-4530G power supply
- » Two Ethernet ports (i210) connected in 1000Base-T mode
- » 16 GB DDR3L SDRAM in dual-channel mode
- » One self-powered USB 2.0 hub (for mouse and keyboard)

The operating systems used were uEFI Shell and Windows® 8.1, 64-bit. All measurements were conducted at an ambient temperature of 25 °C. The power consumption values indicated in the tables below can vary depending on the ambient temperature.

The power consumption was measured using the following the processors:

- » Quad-core Intel® Core™ i7-5700EQ, 2.6 GHz, 6 MB L3 cache, GT2, Intel® HD Graphics 5600
- » Dual-core Intel® Core™ i5-4410E, 2.9 GHz, 3 MB L3 cache, GT2, Intel® HD Graphics 4600
- » Dual-core Intel® Core™ i3-4112E, 1.8 GHz, 3 MB L3 cache, GT2, Intel® HD Graphics 4600

The power consumption was measured using the following configurations:

- » **Workload: uEFI Shell**
For this measurement the processor cores were active, the graphics controller was in idle state (no application running).
- » **Workload: Idle**
For this measurement all processor cores and the graphics controller were in idle state (no application running).
- » **Workload: Typical**
For this measurement all processor cores were operating at maximum workload and the graphics controller was performing basic operation (e.g. dual-screen output configuration with no 3D graphics application running). These values represent the power dissipation reached under realistic, OS-controlled applications with the processor operating at maximum performance.
- » **Workload: Maximum**
These values represent the maximum power dissipation achieved through the use of specific tools to heat up the processor cores and graphics controller. These values are unlikely to be reached in real applications.

Table 42: CP3004-SA Power Consumption

WORKLOAD	Intel® Core™ i7-5700EQ 2.6 GHz	Intel® Core™ i5-4410E 2.9 GHz	Intel® Core™ i3-4112E 1.8 GHz
uEFI Shell	22.0 W	19.2 W	13.8 W
Idle	11.8 W	12.7 W	11.7 W
Typical	44.9 W	47.3 W	21.2 W
Maximum	45.0 W	48.0 W	31.9 W

4.3 Power Consumption of CP3004-SA Accessories

The following table indicates the power consumption of the CP3004-SA accessories.

Table 43: Power Consumption of CP3004-SA Accessories

MODULE	POWER CONSUMPTION
DDR3L SDRAM from one to two 18-chip memory modules (JEDEC raw card D)	approx. 5.8 W
SATA Flash module	less than 0.5 W
Gigabit Ethernet (per interface)	less than 0.5 W

4.4 Maximum Power Consumption of XMC Modules

A maximum power of 15 W is available on the XMC slot (located on the CP3004-XMC module) and it can be arbitrarily divided on the 3.3 V and 5 V (VPWR) voltage lines. XMC modules are based on 3.3 V power along with variable power (VPWR) defined as either 5 V or 12 V in the ANSI/VITA 42.0-200x XMC Switched Mezzanine Card Auxiliary Standard specification. On the CP3004-SA, the VPWR is configured to 5 V.

The following table indicates the current of a XMC module.

Table 44: XMC Module Current

VOLTAGE	CONTINUOUS CURRENT	PEAK CURRENT
3.3 V	0.75 A	1.0 A
5 V (VPWR)	2.5 A	3.0 A
+12 V	0.6 A	0.8 A
-12 V	0.4 A	0.4 A

Note: XMC integrators should carefully review the power ratings, cooling capacity and airflow requirements in the application prior to installation of an XMC module on the 8 HP CP3004-SA with CP3004-XMC extension module.

4.5 Current Limits

The CP3004-SA has a hot swap controller for the +3.3V and +5V input voltage. The trip current limits in case of catastrophic failure are:

- » +3.3 V: 16.5 A minimum, 21.9 A maximum
- » +5 V: 33.0 A minimum, 43.8 A maximum

The maximum thermal operating current is 11.0 A for the +3.3 V supply and 17.6 A for the +5 V supply. The customer configuration/application shall not exceed these limits for a maximum operating ambient temperature of 60°C.

5 Thermal Considerations

The thermal characteristic graphs shown in the following sections are intended to serve as guidance for reconciling the required computing power with the necessary system volumetric airflow over the ambient temperature. The graphs contain two curves representing upper level working points based on different levels of average CPU utilization. When operating below the corresponding curve, the CPU runs without any intervention of thermal supervision (Intel® Core™ i7-5700EQ is below 105°C; Intel® Core™ i5-4410E and Intel® Core™ i3-4112E are below 100°C). When operated above the corresponding curve, various thermal protection mechanisms may take effect resulting in temporarily reduced CPU performance or finally in an emergency stop (the CPU is at 130°C) in order to protect the CPU from thermal destruction (in this case the power must be switched off and then on again). In real applications this means that the board can be operated temporarily at a higher ambient temperature or at a reduced flow rate and still provide some margin for temporarily requested peak performance before thermal protection will be activated.

An airflow of 2.0 m/s to 3.0 m/s or a volumetric flow rate of 15 CFM to 20 CFM is a typical value for a standard Kontron ASM rack. For other racks or housings the available airflow will differ. The maximum ambient operating temperature must be determined for such environments.

How to read the diagram in Figures 7 and 9

Select a specific CPU and choose a specific working point. For a given flow rate there is a maximum airflow input temperature (= ambient temperature) provided. Below this operating point, thermal supervision will not be activated. Above this operating point, thermal supervision will become active protecting the CPU from thermal destruction. The minimum airflow rate provided must be more than the value specified in the diagram.

How to read the diagram in Figure 8

Select a specific working point. For a given CPU frequency there is a maximum airflow input temperature (= ambient temperature) provided. Below this operating point, thermal supervision will not be activated. Above this operating point, thermal supervision will become active by reducing the CPU frequency to protect the CPU from thermal destruction. The minimum airflow rate provided must be more than the value specified in the diagram.

Volumetric flow rate

The volumetric flow rate refers to an airflow through a fixed cross-sectional area (i.e. slot width x depth). The volumetric flow rate is specified in m³/h (cubic-meter-per-hour) or cfm (cubic-feet-per-minute) respectively.

Conversion: 1 cfm = 1.7 m³/h; 1 m³/h = 0.59 cfm

Airflow

At a given cross-sectional area and a required flow rate, an average, homogeneous airflow speed can be calculated using the following formula:

Airflow = Volumetric flow rate / area.

The airflow is specified in m/s (meter-per-second) or in fps (feet-per-second) respectively.

Conversion: 1 fps = 0.3048 m/s; 1 m/s = 3.28 fps

The following figures illustrate the thermal operational limits of the CP3004-SA taking into consideration power consumption vs. ambient air temperature vs. airflow rate.

Note: The CP3004-SA must be operated within the thermal operational limits indicated below.

5.1 Operational Limits for the CP3004-SA

Figure 7: CP3004-SA with Intel® Core™ i7-5700EQ, 2.6 GHz

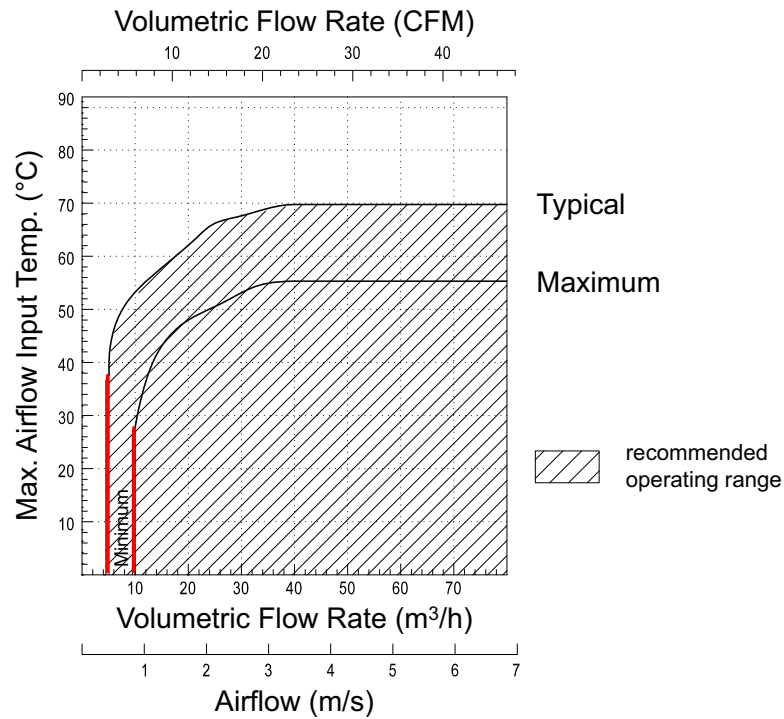

Figure 8: CP3004-SA with Intel® Core™ i5-4410E, 2.9 GHz

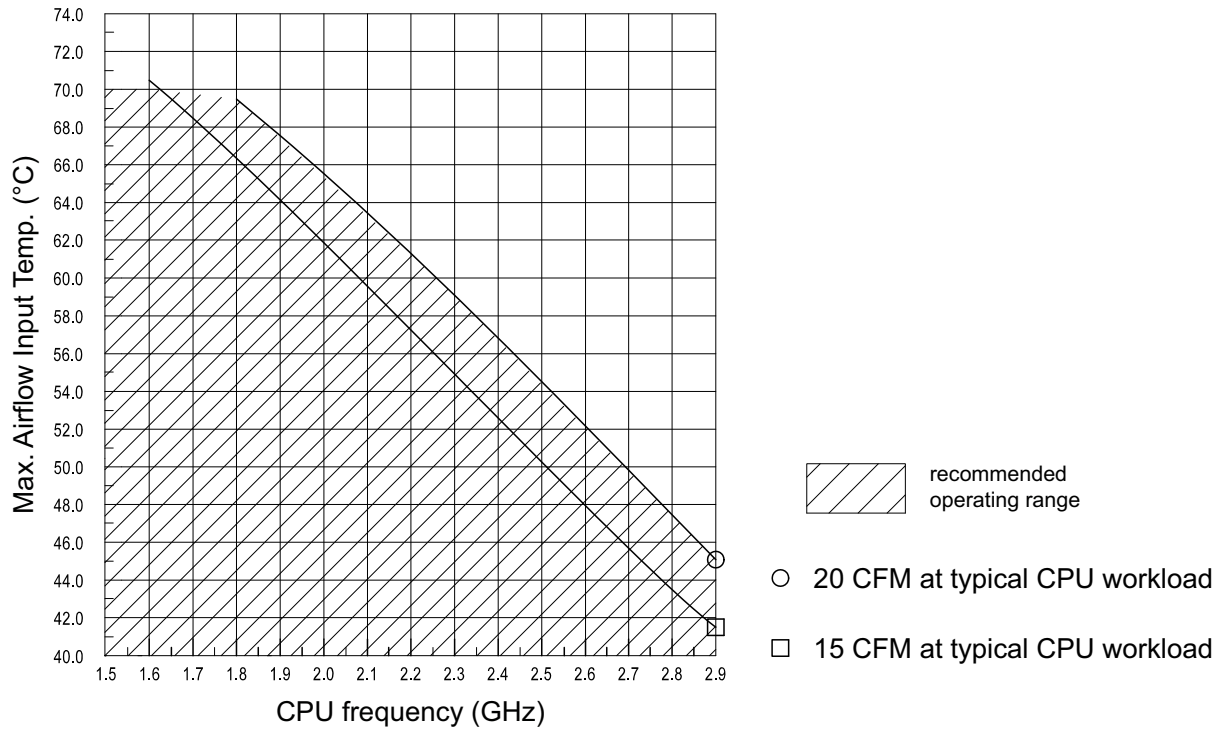
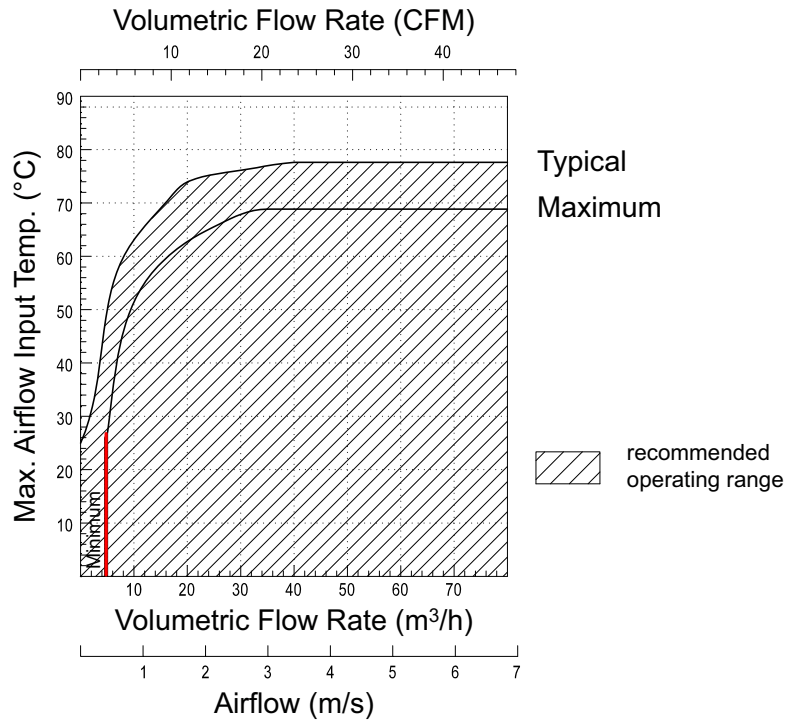

Figure 9: CP3004-SA with Intel® Core™ i3-4112E, 1.8 GHz



6 CP3004-HDD Extension Module

6.1 Overview

The CP3004-HDD is a factory-installed mezzanine extension module which along with an 8 HP / 12 HP front panel provides additional interfaces, such as:

- » Two DisplayPorts
- » One Gigabit Ethernet port
- » One USB 3.0 port
- » One COM port (RJ-45 connector)
- » One Reset switch
- » One SATA activity LED
- » One onboard CFast card socket (8 HP only)
- » One onboard SATA HDD/SSD connector for connecting a 2.5" SATA HDD/SSD
- » One SATA connector for a 2.5" SATA HDD/SSD via a SATA adapter module (12 HP only)
- » Battery socket

Note: If a CP3004-HDD module is used on the CP3004-SA, either the CP3004-SA or the CP3004-HDD module may be equipped with a battery. Using one battery on the CP3004-SA and one on the CP3004-HDD module simultaneously may result in premature discharge of the batteries.

Note: If the CP3004-HDD module is mounted on the CP3004-SA, the SATA Flash module/Smart Extension Module cannot be used with the CP3004-SA.

6.2 Technical Specifications

Table 45: CP3004-HDD Module Specifications

FEATURES		SPECIFICATIONS
Front Panel Interfaces	DisplayPort	Two 20-pin DisplayPort connectors, J1 and J2, for connecting two monitors equipped with a DisplayPort interface (DVI/HDMI-capable through passive cable adapter)
	Gigabit Ethernet	One 10 Base-T/100 Base-TX/1000 Base-T Ethernet interface based on the Intel® 82574L Ethernet PCI Express bus controller: <ul style="list-style-type: none"> » RJ-45 connector, J5 (GbE C) » Automatic mode recognition (Auto-Negotiation) » Automatic cabling configuration recognition (Auto-MDI/X) » Wake-on-LAN support
	USB	One USB 3.0, type A connector, J7
	Serial Port	One 16C550-compatible serial port, COMA, RJ-45 connector, J8

Table 45: CP3004-HDD Module Specifications (Continued)

FEATURES		SPECIFICATIONS
Onboard Interfaces	SATA	Up to two SATA connectors: <ul style="list-style-type: none"> » One SATA connector, J6, for connecting a SATA 2.5" HDD/SSD (8 HP) » One SATA connector, J4, for connecting an additional SATA 2.5" HDD/SSD (12 HP)
	CFast	One CFast card socket, J3 (available on 8 HP version only)
	Board-to-Board	Two board-to-board connectors: <ul style="list-style-type: none"> » One 60-pin, high-speed I/O extension connector, J4, for connecting the CP3004-HDD to the SATA adapter module (12 HP) » One 120-pin, high-speed I/O extension connector for connecting the CP3004-HDD to the CP3004-SA (bottom view)
LEDs/ Switches	HDD LED	One LED (green) monitors SATA HDD/SSD activity
	Front Panel Switch	Reset button, guarded
General	Power Consumption	Power consumption without hard disk, CFast card and peripheral devices connected: 200 mA at 3.3 V
	Temperature Range	Operational: 0°C to +60°C Standard -40°C to +85°C Extended (with Intel® Core™ i3-4112E processor only; the performance may be lowered depending on the airflow in the system) Storage: -40°C to +85°C Without hard disk and without battery -40°C to +65°C With hard disk Note: When a battery is installed, refer to its operational specifications as this may limit the operating and storage temperature of the CP3004-SA (see "Battery" below).
	Battery	3.0V lithium battery for RTC; Battery type: UL-recognized CR2025 Temperature ranges: Operational (load): -20°C to +70°C typical (refer to the battery manufacturer's specifications for exact range) Storage (no load): -40°C to +70°C typical
	Climatic Humidity	93% RH at 40°C, non-condensing (acc. to IEC 60068-2-78)
	Dimensions	CP3004-HDD: 100 mm x 160 mm CP3004-SA with CP3004-HDD: 3U, 8 HP / 12 HP, CompactPCI-compliant form factor
	Board Weight	8 HP CP3004-SA with CP3004-HDD: 459 grams (with heat sink, front panel, two 2 GB SODIMM memory modules and battery, but without CFast card and without 2.5" HDD/SSD) 12 HP CP3004-SA with CP3004-HDD: 519 grams (with heat sink, front panel, two 2 GB SODIMM memory modules, battery, SATA adapter, but without CFast card and without 2.5" HDD/SSD)

6.3 CP3004-HDD Module Functional Block Diagram

Figure 10: CP3004-HDD Module Functional Block Diagram

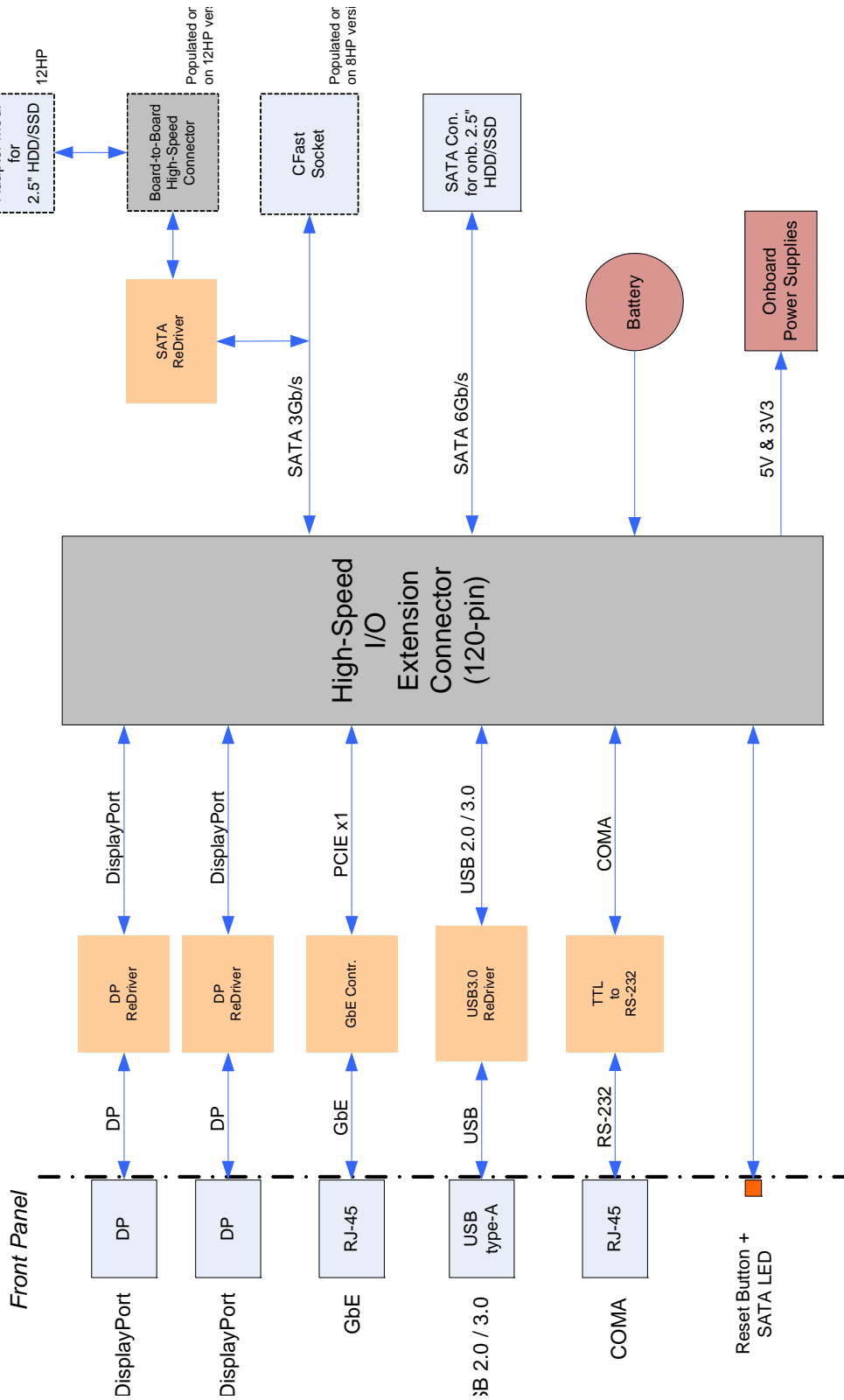

6.4 Front Panel of the CP3004-SA with CP3004-HDD Module

Figure 11: Front Panel of the 8 HP and 12 HP CP3004-SA with CP3004-HDD Module

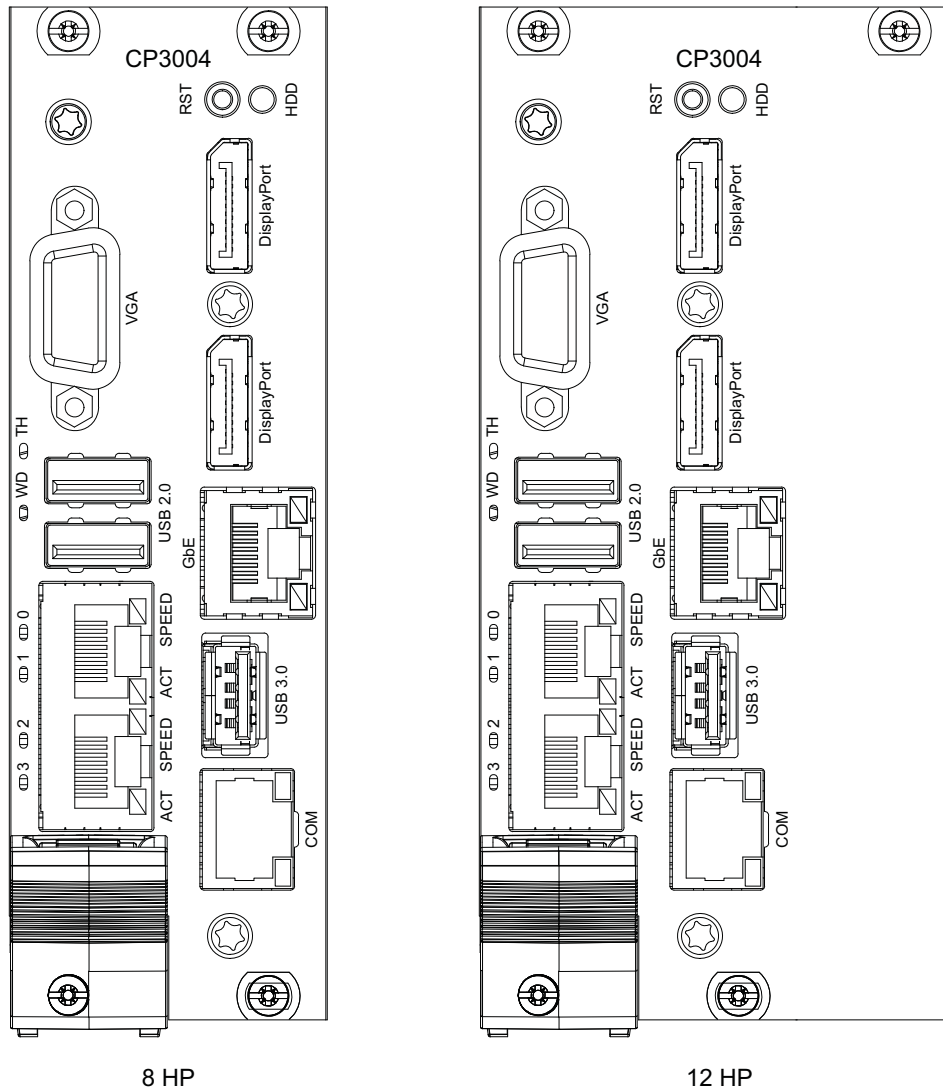

Watchdog and Overtemperature Status LEDs

WD (green):	Watchdog Status
TH (red/green):	Overtemperature Status

Integral Ethernet LEDs

ACT (green):	Ethernet Link/Activity
SPEED (green/orange/off):	Ethernet Speed

General Purpose LEDs

LEDO..3 (red/green/red+green): General Purpose/ POST Code

Note: If the General Purpose LEDs 0..3 are lit red during boot-up, a failure is indicated before the uEFI BIOS has started.

6.5 CP3004-HDD Module Layout

Figure 12: CP3004-HDD Module Layout for 8 HP Board Version (Top View)

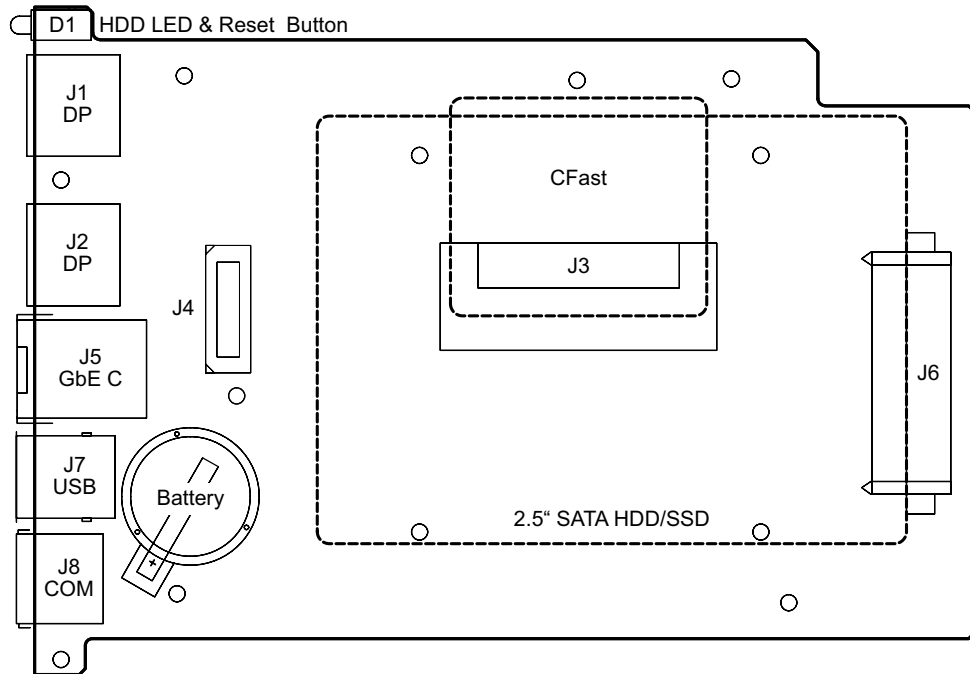

Figure 13: CP3004-HDD Module Layout for 12 HP Board Version (Top View)

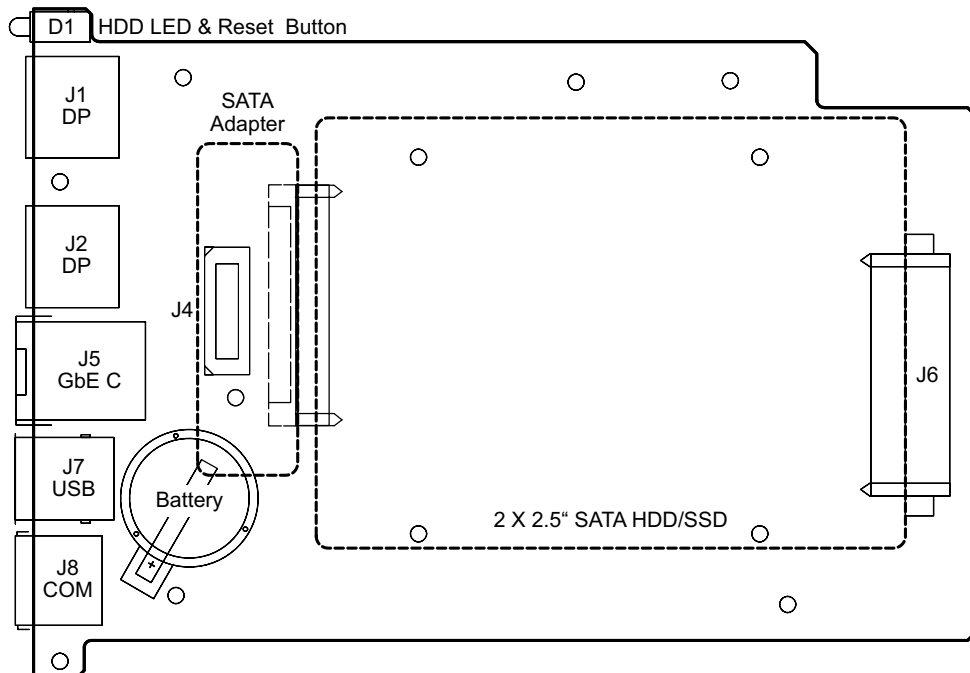
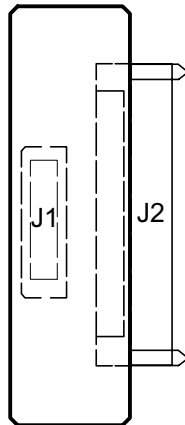

Figure 14: SATA Adapter for 2.5" SATA HDD/SSD (Top view)

6.6 Module Interfaces

6.6.1 DisplayPort Interfaces

The CP3004-HDD provides two standard DisplayPort interfaces for connection to two monitors. The interfaces are implemented as standard DisplayPort connectors, J1 and J2, on the front panel.

6.6.2 Gigabit Ethernet Interface

The CP3004-HDD extension module includes one 10Base-T/100Base-TX/1000Base-T Ethernet port based on one Intel® 82574L Gigabit Ethernet controller, which is connected to the x1 PCI Express interfaces of the Intel® QM87 Express Chipset. The Wake-on-LAN feature is supported.

The Gigabit Ethernet interface is implemented as one standard, RJ-45 connector, J5 (GbE C) on the front panel.

6.6.3 USB Interface

The CP3004-HDD provides one standard, type A, USB 3.0 connector, J7.

Note: Boards with a USB 3.0 flash drive installed on the front panel USB 3.0 port have been found to slightly exceed the electromagnetic interference limits. If permanent USB 3.0 type external storage is required to be connected to the USB 3.0 port, it is recommended to use an external hard disk drive.

6.6.4 Serial Port

One PC-compatible, serial RS-232 port (COMA) is available, which is fully compatible with the 16C550 controller. This port includes a complete set of handshaking and modem control signals. Data transfer rates up to 115.2 kB/s are supported. The serial port is implemented as an 8-pin RJ-45 connector, J8.

Figure 15: Serial Port Connector J8

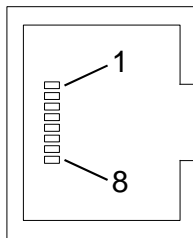

Table 46: Serial Port Connector J8 Pinout

PIN	SIGNAL	DESCRIPTION	I/O
1	RTS	Request to send	O
2	DTR	Data terminal ready	O
3	TXD	Transmit data	O
4	GND	Signal ground	--
5	GND	Signal ground	--
6	RXD	Receive data	I
7	DSR	Data send request	I
8	CTS	Clear to send	I

6.6.5 CFast Interface

To enable flexible flash expansion, a standard CFast card socket, J4, is available on the 8 HP CP3004-SA with CP3004-HDD. However, the 12 HP CP3004-SA does not provide CFast card support.

6.6.6 SATA Interface

The CP3004-HDD extension module provides two SATA connectors, one 29-pin standard SATA connector, J6, for connection to 2.5" SATA HDD/SSD, and one 60-pin, standard high-speed I/O extension connector, J4, for connection to the SATA adapter module, which enables the installation of an additional 2.5" SATA HDD/SSD. The SATA adapter module, expands the CP3004-SA to 12 HP.

7 CP3004-XMC Extension Module

7.1 Overview

The CP3004-XMC is a factory-installed mezzanine extension module which along with an 8 HP front panel provides additional interfaces, such as:

- » One onboard XMC connector for connecting one x8, x4, or x1 PCI Express 2.0 XMC module
- » One onboard CFast card socket
- » One Reset switch
- » One SATA activity LED

Note: XMC modules providing support for one x8 PCI Express 2.0 interface with up to 5.0 GT/s, compliant with the ANSI/VITA 42.0 and ANSI/VITA 42.3 specifications, and with a power consumption of up to 15 W can be used on the CP3004-XMC module.

Note: If the CP3004-XMC module is mounted on the CP3004-SA, the SATA Flash module/Smart Extension Module cannot be used with the CP3004-SA.

7.2 Technical Specifications

Table 47: CP3004-XMC Module Specifications

FEATURES		SPECIFICATIONS
Onboard Interfaces	XMC	XMC interface for support of one x8, x4, or x1 PCI Express 2.0 XMC module via a standard XMC connector, J1
	CFast	One CFast card socket, J2
	Board-to-Board	Two board-to-board connectors: <ul style="list-style-type: none"> » One 60-pin, high-speed PCI Express extension connector, J5 » One 120-pin, high-speed I/O extension connector, J6
LEDs/ Switches	HDD LED	One LED (green) monitors SATA HDD/SSD activity
	Front Panel Switch	Reset button, guarded
General	Power Consumption	Power consumption without hard disk, CFast card and peripheral devices connected: 50 mA at 3.3 V 50 mA at 5 V
	Temperature Range	Operational: 0°C to +60°C Standard -40°C to +85°C Extended (with Intel® Core™ i3-4112E processor only; the performance may be lowered depending on the airflow in the system) Storage: -40°C to +85°C Without hard disk and without battery -40°C to +65°C With hard disk
	Climatic Humidity	93% RH at 40°C, non-condensing (acc. to IEC 60068-2-78)
	Dimensions	CP3004-XMC: 100 mm x 160 mm CP3004-SA with CP3004-XMC: 3U, 8 HP CompactPCI-compliant form factor
	Board Weight	8 HP CP3004-SA with CP3004-XMC: 434 grams (with heat sink, front panel, and two 2 GB SODIMM memory modules, but without CFast card)

7.3 CP3004-XMC Module Functional Block Diagram

Figure 16: CP3004-XMC Module Functional Block Diagram

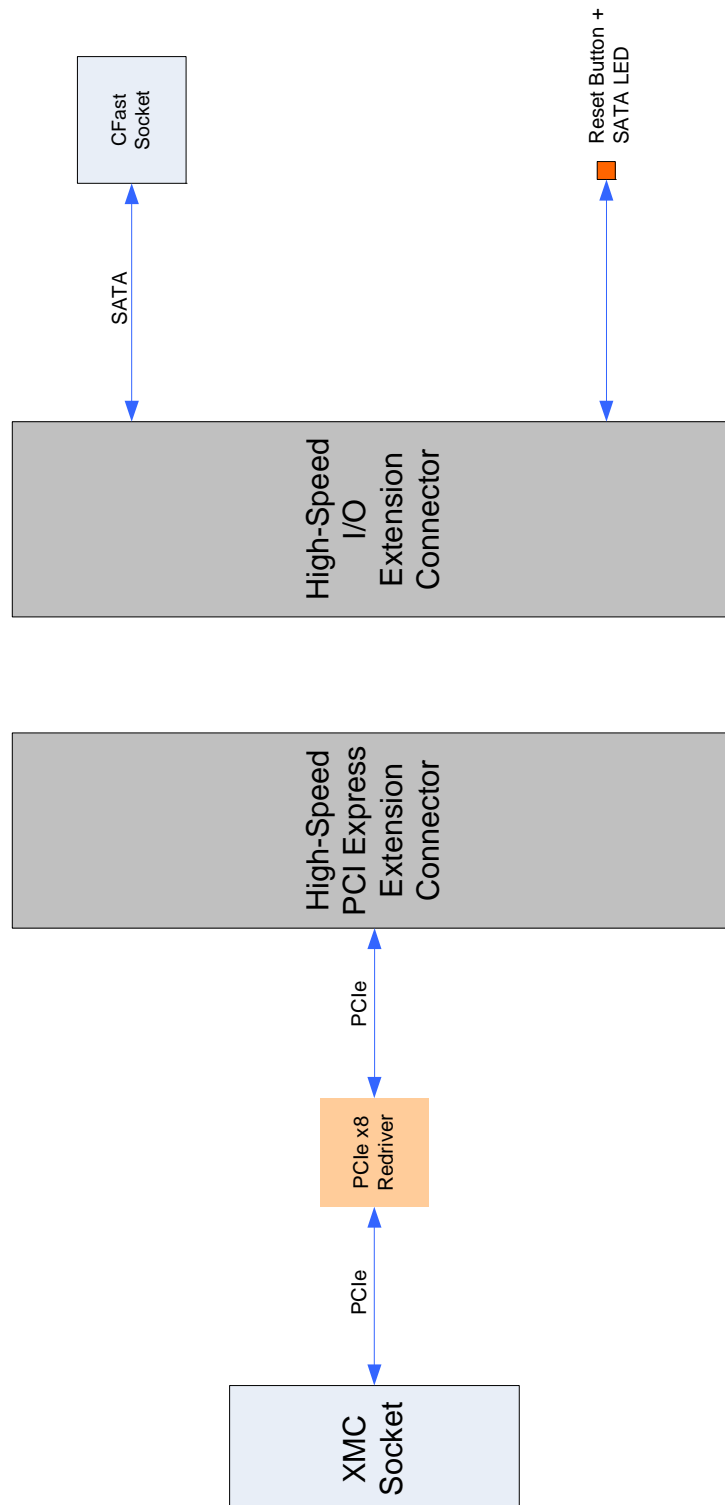

7.4 Front Panel of the CP3004-SA with CP3004-XMC Module

Figure 17: Front Panel of the 8 HP and 12 HP CP3004-SA with CP3004-XMC Module

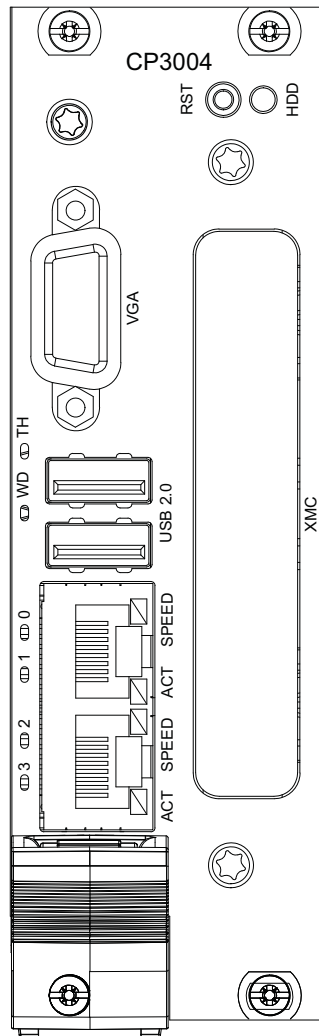

Watchdog and Overtemperature Status LEDs

WD (green):	Watchdog Status
TH (red/green):	Overtemperature Status

Integral Ethernet LEDs

ACT (green):	Ethernet Link/Activity
SPEED (green/orange/off):	Ethernet Speed

General Purpose LEDs

LEDO..3 (red/green/red+green): General Purpose/ POST Code

Note: If the General Purpose LEDs 0..3 are lit red during boot-up, a failure is indicated before the uEFI BIOS has started.

7.5 CP3004-XMC Module Layout

Figure 18: CP3004-XMC Module Layout for 8 HP Board Version (Top View)

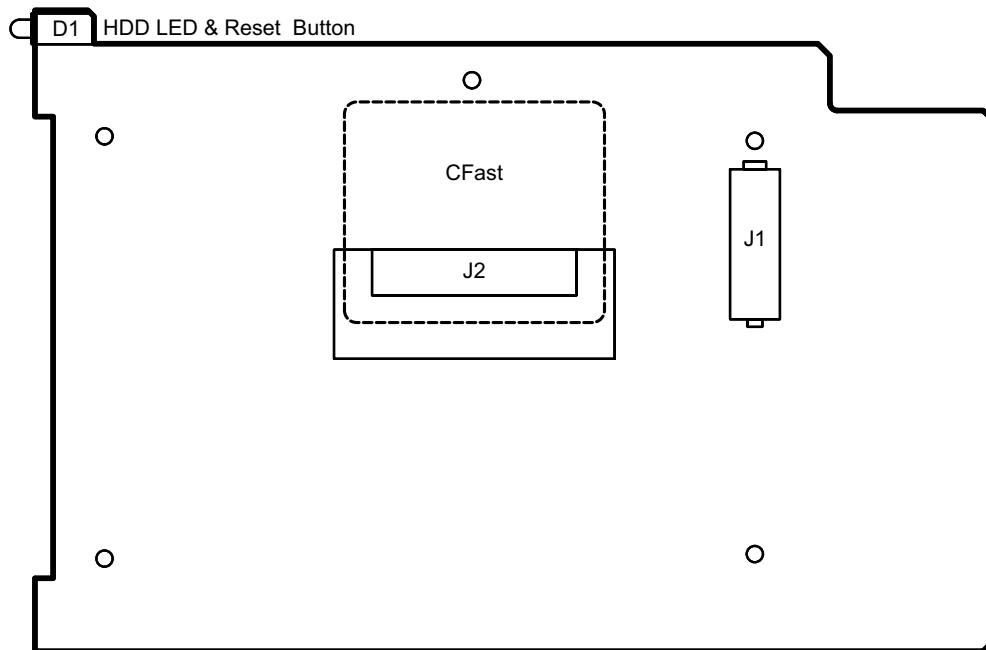
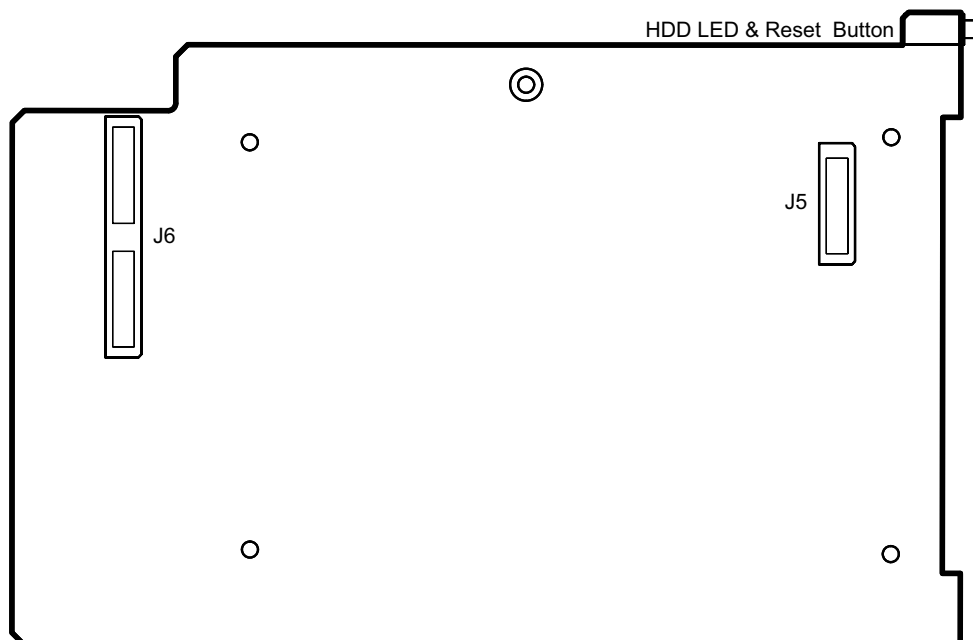

Figure 19: CP3004-XMC Module Layout for 8 HP Board Version (Bottom View)



7.6 Module Interfaces

7.6.1 CFast Interface

To enable flexible flash expansion, a standard CFast card socket, J2, is available on the 8 HP CP3004-SA with CP3004-XMC.

7.6.2 XMC Interface

The CP3004-XMC uses one x8 PCI Express 2.0 interface operating at up to 5.0 GT/s and compliant with the ANSI/VITA 42.0 and ANSI/VITA 42.3 specifications. It provides one standard XMC connector, J1, for connection to an XMC module. The CP3004-XMC supports XMC modules with a maximum power consumption of 15 W.

8 CP-RI03-04 Rear Transition Module

8.1 Overview

The CP3004-SA provides optional rear I/O connectivity for peripherals. Some standard PC interfaces are implemented and assigned to the front panel and to the rear I/O connector J2 on the CP3004-SA. When the CP-RI03-04 rear transition module is used, some signals of main board/front panel connectors are routed to the module interface.

To support the rear I/O feature, a 3U CompactPCI backplane with rear I/O support is required. The CP-RI03-04 rear transition module provides the following interfaces.

- » CompactPCI rear I/O
- » Two USB 2.0 ports
- » Two Gigabit Ethernet ports without LED signals
- » Two COM ports
- » One VGA analog port
- » Two SATA ports
- » Power supply management

8.2 Technical Specifications

Table 48: CP-RI03-04 Rear Transition Module Specifications

FEATURES		SPECIFICATIONS
External Interfaces	USB 2.0	Two USB 2.0 type A connectors, J11 and J12
	VGA	One VGA interface implemented as a 15-pin, D-Sub connector, J7
	Ethernet	Two Gigabit Ethernet interfaces implemented as a dual RJ-45 connector without LEDs, J10A/B
	Serial	Two onboard RS-232 serial ports with full modem support COMA (COM1) and COMB (COM2) implemented as: <ul style="list-style-type: none"> » 10-pin onboard connectors J2 (COMA) and J3 (COMB) on the 4 HP version » 9-pin, D-Sub connectors, J2a (COMA) and J3a (COMB) on the 8HP version
Internal Interfaces	CompactPCI	CompactPCI connector, rJ2, for rear I/O backplane connection
	SATA	Two SATA interfaces implemented as two 7-pin, L-form standard SATA connectors
	Serial	Two COM ports (COMA and COMB) implemented as two 10-pin, 2.54 mm onboard connectors with full modem support, J2 (COMB) and J3 (COMA) On the 8HP version, the serial ports are routed to the front panel and implemented as two 9-pin, D-Sub connectors, J2a (COM1) and J3a (COM2).
	Peripheral Control	One 10-pin, 2.54 mm onboard connector for power supply management, J13
General	Temperature Range	Operational: 0°C to +60°C Storage: -55°C to +85°C
	Climatic Humidity	93% RH at 40°C, non-condensing (acc. to IEC 60068-2-78)
	Dimensions	100 mm x 80 mm
	Board Weight	4 HP: 120 grams 8HP: 150 grams

8.3 CP-RIO3-04 Front Panels

Figure 20: CP-RIO3-04 4HP and 8HP Front Panels

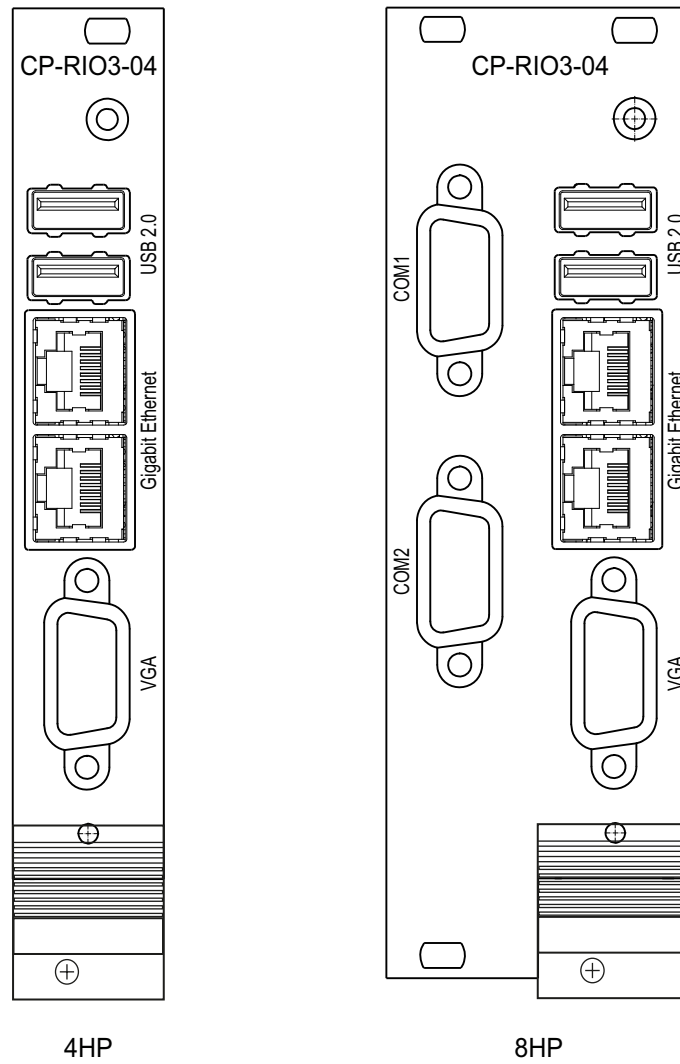

8.4 CP-RI03-04 Rear Transition Module Layout

Figure 21: 4HP CP-RI03-04 Rear Transition Module Layout

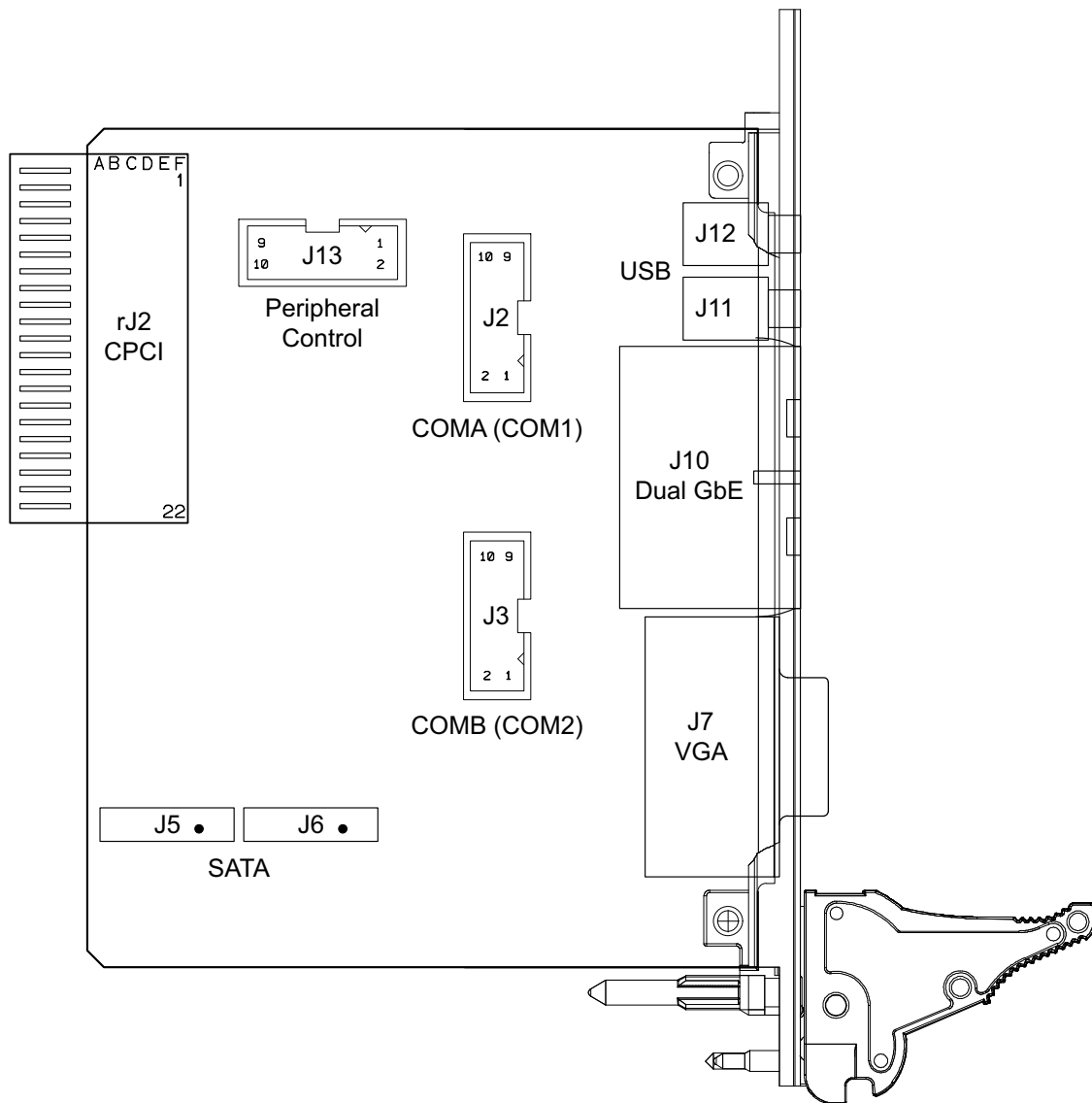
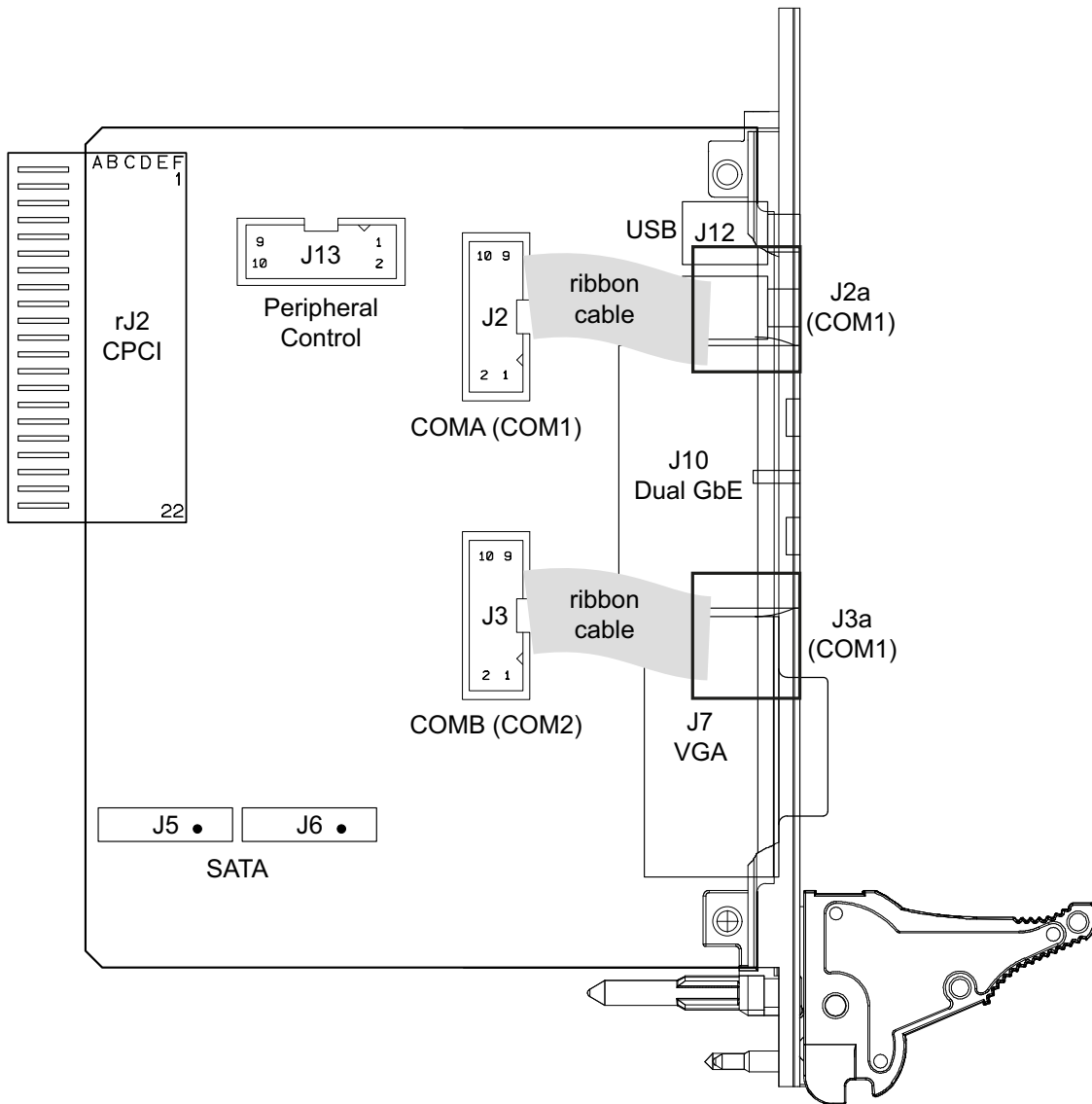

Figure 22: 8HP CP-RI03-04 Rear Transition Module Layout



8.5 Module Interfaces

8.5.1 USB Interfaces

The CP-RI03-04 rear transition module provides two standard, type A, USB 2.0 connectors, J11 and J12, on the front panel.

8.5.2 VGA Interface

The CP-RI03-04 provides one standard VGA interface for connection to a monitor. The VGA interface is implemented as a standard VGA connector, J7, on the front panel.

8.5.3 Gigabit Ethernet Interface

The CP-RI03-04 provides two Gigabit Ethernet interfaces realized as RJ-45 connectors without LEDs. The interface provides automatic detection and switching between 10Base-T, 100Base-TX and 1000Base-T data transmission (Auto-Negotiation). Auto-wire switching for crossed cables is also supported (Auto-MDI/X).

8.5.4 COM Interface

The CP-RI03-04 rear transition module provides two identical COM ports for connection to RS-232 devices. On the 8 HP version, the onboard 10-pin serial connectors J2 and J3 are routed to the 9-pin D-Sub COM connectors J2a and J3a located on the front panel. On the 4 HP version, the COM signals are available only on the onboard 10-pin serial port connectors J2 and J3.

The following table provides pinout information for the onboard serial port connectors J2 and J3. Refer to the module layout for connector and pin locations.

Table 49: Serial Port Connectors J2 (COMB) and J3 (COMA) Pinout

PIN	SIGNAL	DESCRIPTION	I/O
1	DCD	Data carrier detect	I
2	DSR	Data send request	I
3	RXD	Receive data	I
4	RTS	Request to send	O
5	TXD	Transmit data	O
6	CTS	Clear to send	I
7	DTR	Data terminal ready	O
8	RI	Ring indicator	I
9	GND	Signal ground	--
10	NC	Not connected	--

8.5.5 Peripheral Control Interface

A power supply with power management can be connected to the CP-RI03-04 rear transition module via the peripheral control connector J13.

The following table provides pinout information for the peripheral control connector J13. Refer to the module layout for connector and pin locations.

Table 50: Peripheral Control Connector J13 Pinout

PIN	SIGNAL	DESCRIPTION	I/O
1	GND	Signal ground	--
2	PWR_5VSTDBY	+5V standby power (optional)	I
3	RSV	Reserved	--
4	VCC5V	Power +5V	O
5	RSV	Reserved	--
6	VCC3V3	Power +3.3V	O
7	PWR_SLPS3#	Power supply sleep mode	O
8	GND	Signal ground	--
9	PWR_BTN#	Wake-up / sleep input	I
10	GND	Signal ground	--

8.5.6 SATA Interfaces

The onboard SATA connectors J5 and J6 allow the connection of standard HDDs/SSDs and other SATA devices to the CP-RI03-04 rear transition module.

8.5.7 Rear I/O Interface on CompactPCI Connector rJ2

The CP-RI03-04 rear transition module conducts a wide range of I/O signals through the rear I/O connector rJ2.

Note: To support the rear I/O feature, a 3U CompactPCI backplane with rear I/O support is required. Do not plug a rear I/O configured board in a backplane without rear I/O support. Failure to comply with the above will result in damage to your board.

Figure 23: Rear I/O CompactPCI Connector rJ2

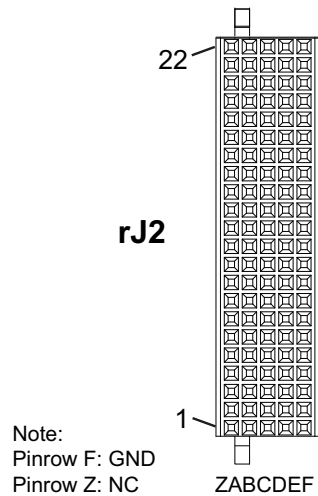

Table 51: Rear I/O CompactPCI Connector rJ2 Pinout

PIN	Z	A	B	C	D	E	F
22	NC	NC	NC	NC	NC	NC	GND
21	NC	NC	GND	USBA+/bi	USBB+/bi	USBA_PWR_5V/ in	GND
20	NC	NC	GND	USBA-/bi	USBB-/bi	USBB_PWR_5V/ in	GND
19	NC	GND	GND	PWR_BTN#/out	PWR_SLPS3#/in	RIO_3.3V/in	GND
18	NC	COMA_RXD/out	COMA_DCD#/out	COMA_DTR#/in	COMB_CTS# /out	COMA_CTS#/out	GND
17	NC	COMA_TXD/in	COMB_RXD/out	NC	NC	NC	GND
16	NC	COMA_DSR#/out	COMA_RTS#/in	NC	RSV	COMA_RI#/out	GND
15	NC	PWR_5VSTDBY/out	RSV	NC	NC	NC	GND
14	NC	IPA_DA+/bi	IPA_DA-/bi	COMB_RTS#/in	IPA_DC+/bi	IPA_DC-/bi	GND
13	NC	IPA_DB+/bi	IPA_DB-/bi	COMB_RI#/out	IPA_DD+/bi	IPA_DD-/bi	GND
12	NC	IPB_DA+/bi	IPB_DA-/bi	RIO_XFO_CT	IPB_DC+/bi	IPB_DC-/bi	GND
11	NC	IPB_DB+/bi	IPB_DB-/bi	COMB_DCD#/out	IPB_DD+/bi	IPB_DD-/bi	GND
10	NC	GND	COMB_TXD/in	VGA_RED/in	COMB_DTR#/in	GND	GND
9	NC	SATAATX+/in	GND	VGA_HSYNC/in	GND	SATABTX+/in	GND
8	NC	SATAATX-/in	GND	VGA_BLUE/in	GND	SATABTX-/in	GND
7	NC	GND	COMB_DSR#/out	VGA_DDC_DATA/bi	RSV	GND	GND
6	NC	SATAARX+/out	GND	VGA_GREEN/in	GND	SATABRX+/out	GND
5	NC	SATAARX-/out	GND	VGA_VSYNC/in	GND	SATABRX-/out	GND
4	NC	NC	RIO_5V/in	VGA_DDC_CLK/in	GPIO_CFG0/out	GND	GND
3	NC	NC	GND	NC	NC	NC	GND
2	NC	NC	NC	NC	NC	NC	GND
1	NC	NC	NC	NC	NC	NC	GND

Note: The RIO_XXX signals are power supply **INPUTS** to supply the rear I/O module with power. These pins **MUST NOT** be connected to any other power source, either within the backplane itself or within a rear I/O module. Failure to comply with the above will result in damage to your board.

Table 52: Rear I/O Signal Description

SIGNAL	DESCRIPTION
COMAx	COMA port LVTTTL (3.3V)
COMBx	COMB port LVTTTL (3.3V)
GPIO_CFG0	GPIO or COMB configuration
IPx	Gigabit Ethernet copper port
SATAx	SATA port
USBx	USB interface and power
VGAx	VGA signal
RIOx/V(I/O)	Power supply signal
PWRx	Power management signal
RSV	Reserved
GND	Ground signal
NC	Not connected

9 SATA Flash Module

9.1 Overview

The 4 HP CP3004-SA provides an optional SATA Flash module with up to 32 GB NAND flash memory. The SATA Flash module is connected to the CP3004-SA via the J12 connector located on the CP3004-SA and the J1 connector located on the SATA Flash module.

Note: If the SATA Flash module is mounted on the CP3004-SA, the Smart Extension Module, the CP3004-HDD module and the CP3004-XMC module cannot be used with the CP3004-SA.

9.2 Technical Specifications

Table 53: SATA Flash Module Specifications

FEATURES		SPECIFICATIONS
Interface	Board-to-Board Connector	One 18-pin, female, board-to-board connector, J1
Memory	Memory	Mezzanine module providing: <ul style="list-style-type: none"> » Up to 32 GB SLC-based NAND flash memory » Built-in full hard disk emulation » Up to 60 MB/s read rate » Up to 55 MB/s write rate
General	Power Consumption	typ. 0.5 W 3.3 V supply
	Temperature Range	Operational: 0°C to +60°C Standard -40°C to +85°C Extended Storage: -40°C to +85°C
	Climatic Humidity	93% RH at 40°C, non-condensing (acc. to IEC 60068-2-78)
	Dimensions	38 mm x 27 mm
	Board Weight	ca. 6 grams

Note: Write protection is available for the SATA Flash module. Please contact Kontron for further assistance if write protection is required.

9.3 SATA Flash Module Layout

Figure 24: SATA Flash Module Layout (Top and Bottom Views)

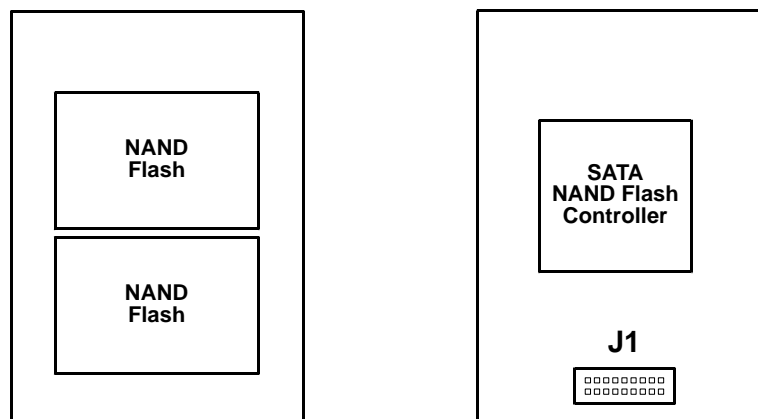

10 Smart Extension Module

10.1 Overview

For the 4 HP CP3004-SA there is an optional Smart Extension Module for facilitating the connection to system-internal USB and SATA devices. The Smart Extension Module includes one SATA cable connector as well as one USB 2.0 connector.

Note: When the Smart Extension Module is mounted on the CP3004-SA, the SATA Flash module, the CP3004-HDD module and the CP3004-XMC module cannot be used with the CP3004-SA.

10.2 Technical Specifications

Table 54: Smart Extension Module Specifications

FEATURES		SPECIFICATIONS
Interfaces	USB Connector	One 4-pin, type A, standard USB 2.0 connector, J2
	SATA Connector	One 7-pin, L-form standard SATA connector, J1
General	Temperature Range	Operational: 0°C to +60°C Standard -40°C to +85°C Extended Storage: -40°C to +85°C
	Climatic Humidity	93% RH at 40°C, non-condensing (acc. to IEC 60068-2-78)
	Dimensions	48 mm x 33 mm Note: If a Smart Extension Module is installed on the CP3004-SA, the board exceeds 4 HP.
	Board Weight	11 grams

10.3 Smart Extension Module Layout

Figure 25: Smart Extension Module Layout (Top View)

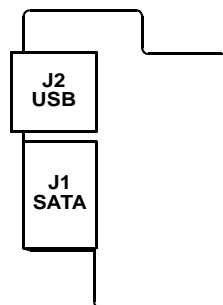

10.4 Module Interfaces

10.4.1 USB Interface

The Smart Extension Module provides one standard, type A, USB 2.0 connector, J2.

10.4.2 SATA Interface

The Smart Extension Module provides one 3Gb/s SATA interface. The SATA interface is implemented as one standard SATA cable connector, J1, which is used to connect a standard HDD/SSD or another SATA device to the CP3004-SA via the Smart Extension Module.

11 Installation

This chapter is oriented towards an application environment. Some aspects may, however, be applicable to a development environment.

11.1 Safety

To ensure personnel safety and correct operation of this product, the following safety precautions must be observed:

- » All operations involving the CP3004-SA require that personnel be familiar with system equipment, safety requirements and the CP3004-SA.
- » This product contains electrostatically sensitive components which can be seriously damaged by electrical static discharge (ESD). Therefore, proper handling must be ensured at all times.
- » Whenever possible, unpack or pack this product only at EOS/ESD safe work stations. Where a safe work station is not guaranteed, it is important for the user to be electrically discharged before touching the product with his/her hands or tools. This is most easily done by touching a metal part of your system housing.
- » Do not handle this product out of its protective enclosure while it is not used for operational purposes unless it is otherwise protected.
- » Do not touch components, connector-pins or traces.

Kontron assumes no liability for any damage resulting from failure to comply with these requirements.

11.2 General Instructions on Usage

In order to maintain Kontron's product warranty, this product must not be altered or modified in any way. Changes or modifications to the device which are not explicitly approved by Kontron and described in this manual or received from Kontron's Technical Support as a special handling instruction will void your warranty.

This device should only be installed in or connected to systems that fulfill all necessary technical and specific environmental requirements. This applies also to the operational temperature range of the specific board version, which must not be exceeded. If batteries are present, their temperature restrictions must be taken into account.

11.3 Board Installation

The CP3004-SA is designed for use either as a CompactPCI system controller or as an autonomous CPU board in a CompactPCI peripheral slot.

When installed in the system slot, the CP3004-SA provides all required functions for supporting the hot swapping of peripheral boards which are capable of being hot swapped. In this configuration the CP3004-SA itself is not hot-swappable.

When installed in a CompactPCI peripheral slot, the CP3004-SA operates autonomously, meaning that it only draws power from the CompactPCI backplane. There is no interfacing with the CompactPCI bus, clocks or other control signals. In this configuration, the CP3004-SA supports hot plugging. This simply means that the board can be installed or removed from the system while under power.

Note: Always ensure that all functions in progress are properly terminated or put into a safe state prior to hot plugging the CP3004-SA. Failure to comply with the above may result in improper operation or damage to other system components, e.g. operating system failure, data loss, uncontrolled processing, etc.

Note: In order to use the hot plug function of the CP3004-SA, a hot swap-capable backplane is required.

11.3.1 Standard Board Insertion

Prior to following the steps below, ensure that the safety requirements are met.

To insert the CP3004-SA in a system proceed as follows:

1. Ensure that no power is applied to the system before proceeding.
2. Insert the board into the slot designated until it makes contact with the backplane connectors.
3. Using the ejector handle, engage the board with the backplane. When the ejector handle is closed, the board is engaged.
4. Fasten the front panel retaining screws.
5. Connect all external interfacing cables to the board as required.

11.3.2 Standard Board Removal

Prior to following the steps below, ensure that the safety requirements are met. When removing a board from the system, particular attention must be paid to the components which may be hot, such as heat sink, etc.

To remove the CP3004-SA from a system proceed as follows:

1. Ensure that no power is applied to the system before proceeding.
2. Disconnect any interfacing cables that may be connected to the board.
3. Unscrew the front panel retaining screws.
4. Unlock the ejector handle.
5. Disengage the board from the backplane by pressing the handle as required and remove the board from the system.

11.4 Installation of CP3004-SA Peripheral Devices

The CP3004-SA is designed to accommodate various peripheral devices, such as USB devices, SATA devices, a CFast card, etc. The following figures show the placement of modules and peripheral devices on the CP3004-SA.

Figure 26: 4 HP CP3004-SA with SATA Flash Module

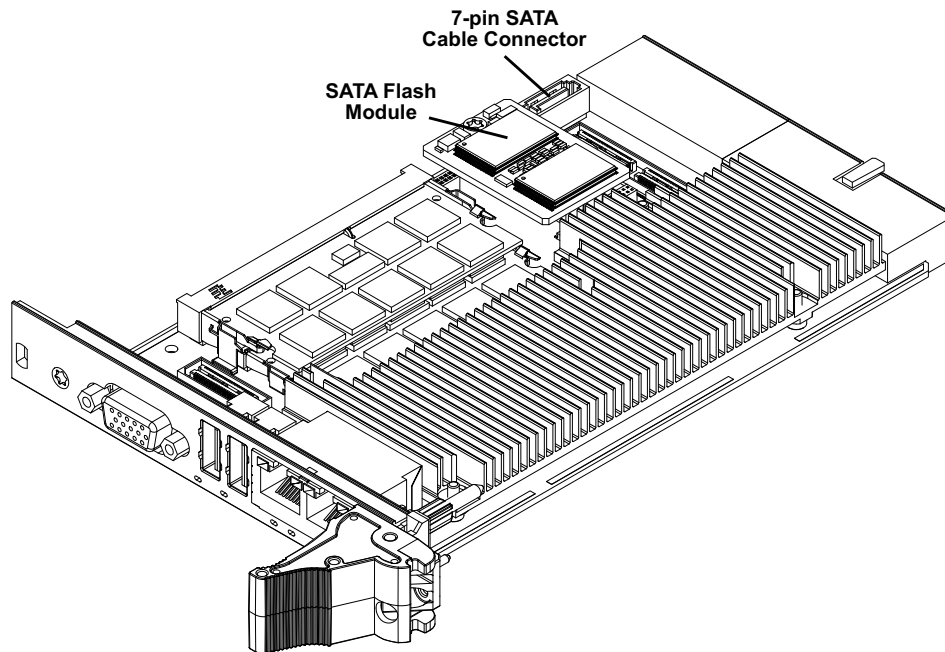

Figure 27: 4 HP CP3004-SA with Smart Extension Module

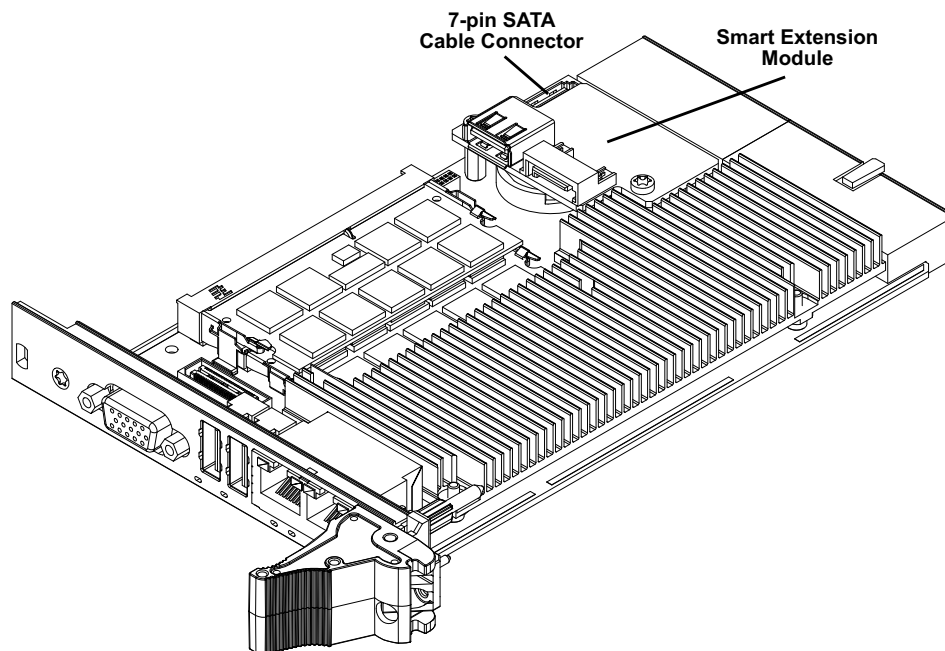

Figure 28: 8 HP CP3004-SA with CP3004-HDD Module

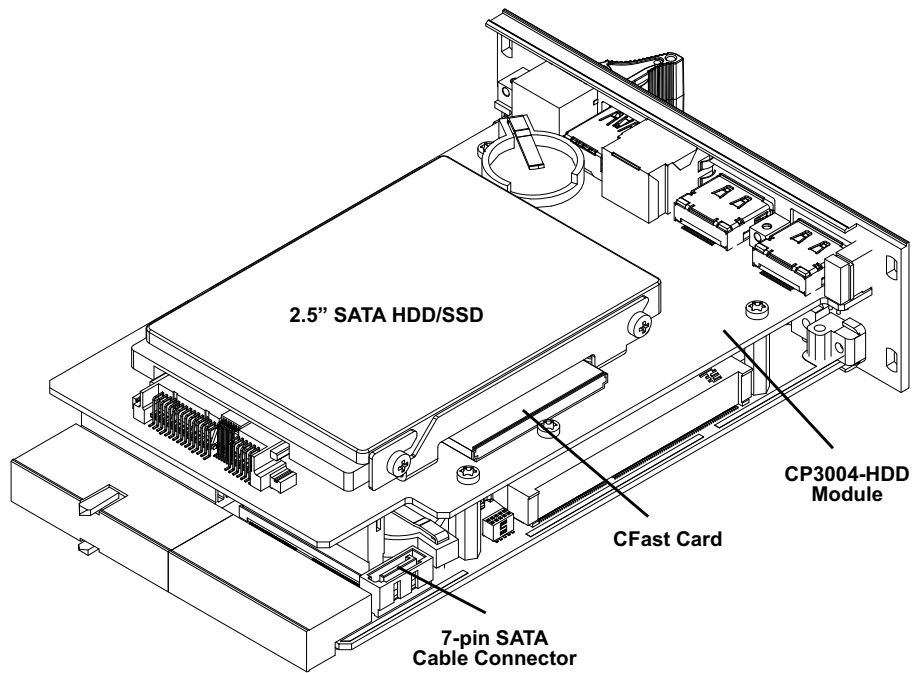

Figure 29: 12 HP CP3004-SA with CP3004-HDD Module and SATA Adapter Module

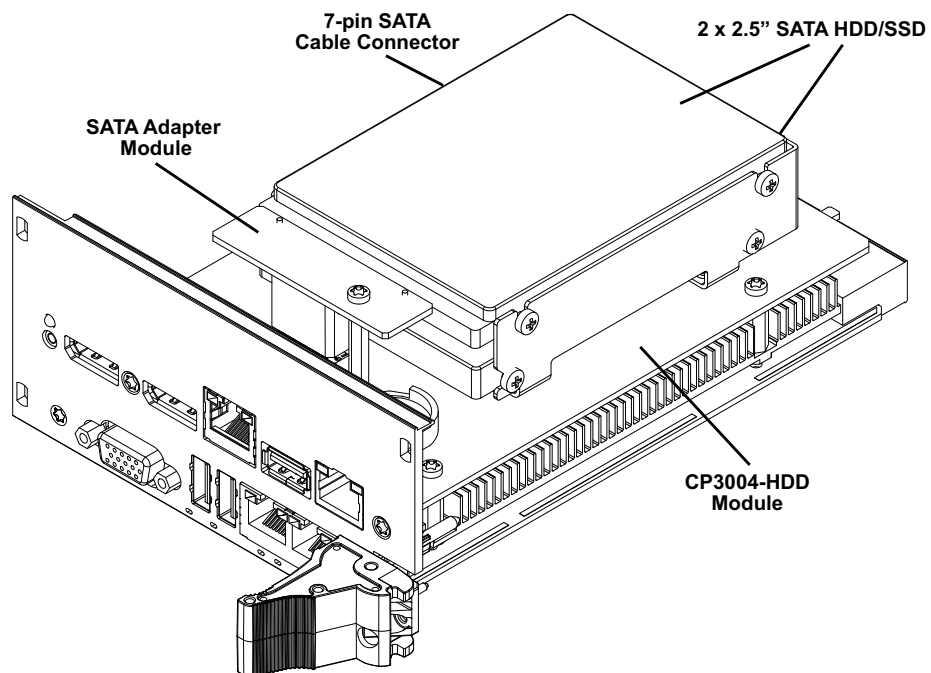
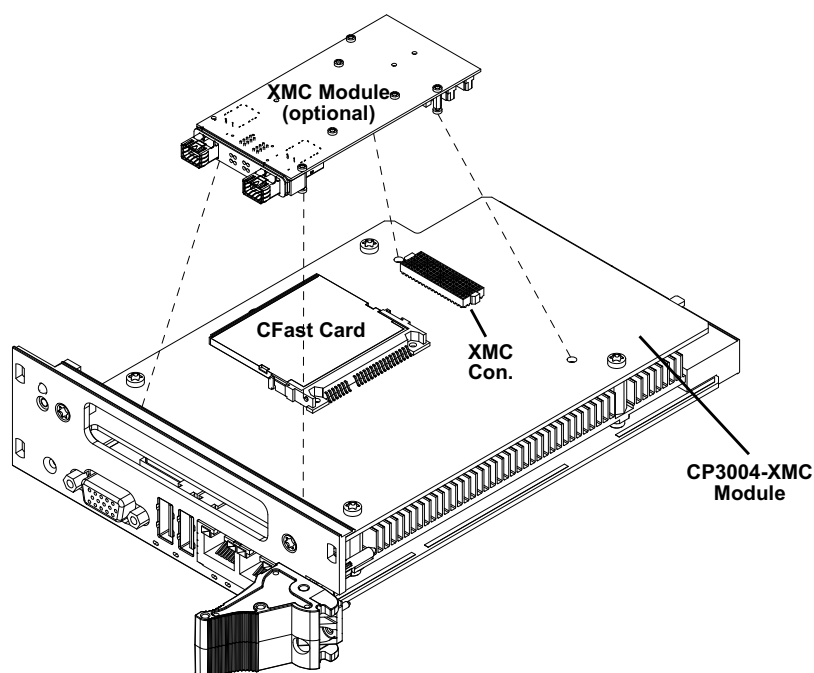

Figure 30: 8 HP CP3004-SA with CP3004-XMC Module

The following chapters provide information regarding installation aspects of peripheral devices.

11.4.1 SATA Flash Module Installation

A SATA Flash module may be connected to the 4 HP CP3004-SA via the onboard connector J12.

This optionally available module must be physically installed on the CP3004-SA prior to installation of the CP3004-SA in a system. During installation it is necessary to ensure that the SATA Flash module is properly seated in the onboard connector J12, i.e. the pins are aligned correctly and not bent.

Note: Only qualified SATA Flash modules from Kontron are authorized for use with the CP3004-SA. Failure to comply with the above will void the warranty and may result in damage to the board or the system.

Note: The SATA Flash module cannot be used in conjunction with the Smart Extension Module, the CP3004-HDD module, and the CP3004-XMC module.

11.4.2 Smart Extension Module Installation

A Smart Extension Module may be connected to the 4 HP CP3004-SA via the onboard connector J14.

This optionally available module must be physically installed on the CP3004-SA prior to installation of the CP3004-SA in a system.

During installation it is necessary to ensure that the Smart Extension Module is properly seated in the onboard connector J14, i.e. the pins are aligned correctly and not bent.

Note: The Smart Extension Module cannot be used in conjunction with the SATA Flash module, the CP3004-HDD module, and the CP3004-XMC module.

11.4.3 Installation of External SATA Devices

The following information pertains to external SATA devices which may be connected to the CP3004-SA via normal cabling.

Some symptoms of incorrectly installed SATA devices are:

- » Device on a SATA channel does not spin up: check power cables and cabling. May also result from a bad power supply or SATA device.
The SATA connector on the CP3004-SA provides only a data connection. The power for this device must be supplied by a separate connector. For further information, refer to the respective documentation of the device.
- » SATA device fail message at boot-up: may be a bad cable or lack of power going to the drive.

11.4.4 2.5" HDD / SSD Installation

Up to two 2.5" SATA HDDs/SSDs may be connected to the CP3004-SA. One HDD/SSD may be connected to the 8 HP CP3004-SA board version equipped with an CP3004-HDD extension module via the SATA connector J6 located on the extension module. An additional HDD/SSD may be connected to the 12 HP CP3004-SA board version equipped with an CP3004-HDD extension module and a SATA adapter module. The second HDD/SSD is connected to the SATA connector J2 located on the SATA adapter module. Please refer to Figures 28 and 29 for the placement of the 2.5" HDDs/SSDs.

11.4.5 XMC Module Installation

The 8 HP CP3004-SA equipped with the CP3004-XMC module provides an XMC connector, J1, for connection to an XMC module such as the Kontron XMC 401, XMC402, etc.

The XMC module must be installed on the CP3004-XMC prior to installation of the CP3004-SA with the CP3004-XMC in a system.

Before installing an XMC module on the CP3004-SA equipped with an CP3004-XMC extension module, ensure that the safety requirements indicated in section 11.1 are observed.

Note: Failure to comply with the instruction below may cause damage to the board or result in improper system operation.

To install an XMC module on the CP3004-SA equipped with an CP3004-XMC extension module, refer to the figures shown below and proceed as follows:

Figure 31: Screws Securing the Front Panel and the CP3004-XMC to the CP3004-SA

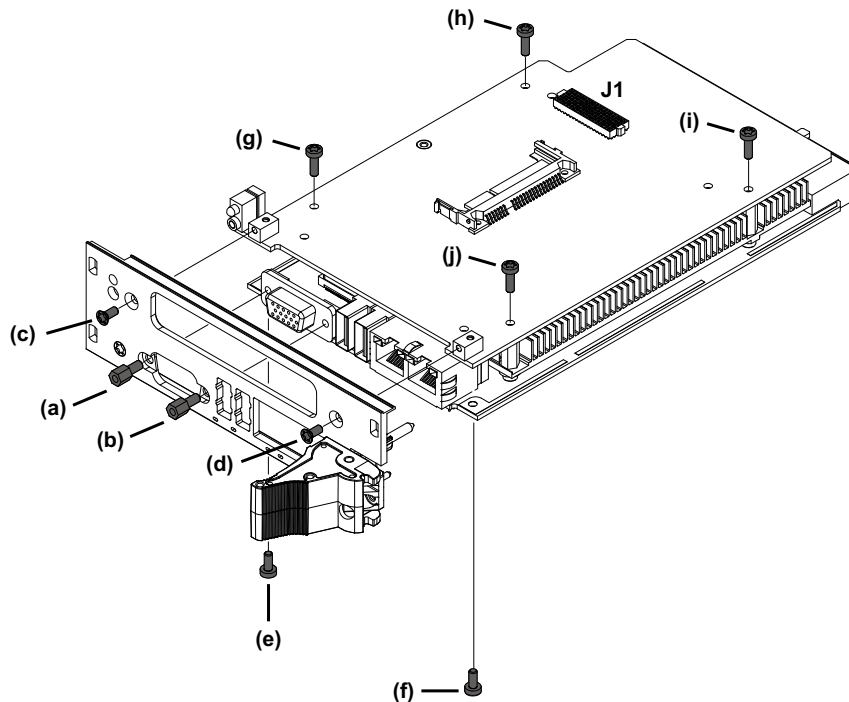

Figure 32: Screws Securing the XMC Module to the CP3004-XMC Extension Module

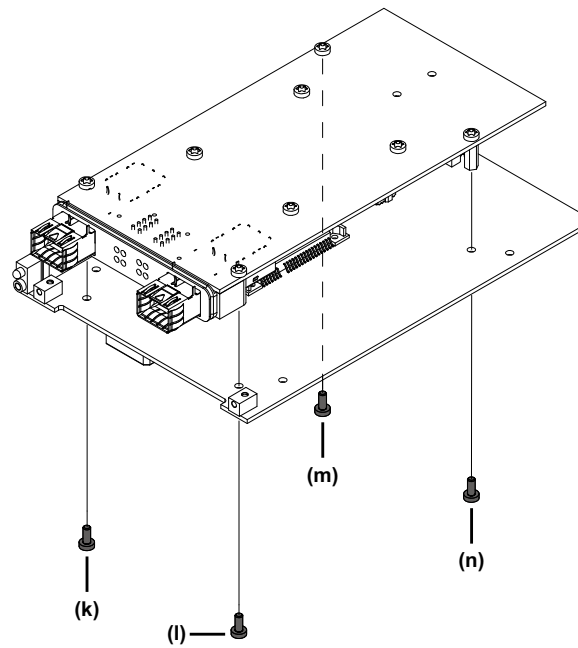

Figure 33: CP3004-SA Board with CP3004-XMC Extension Module and XMC Module

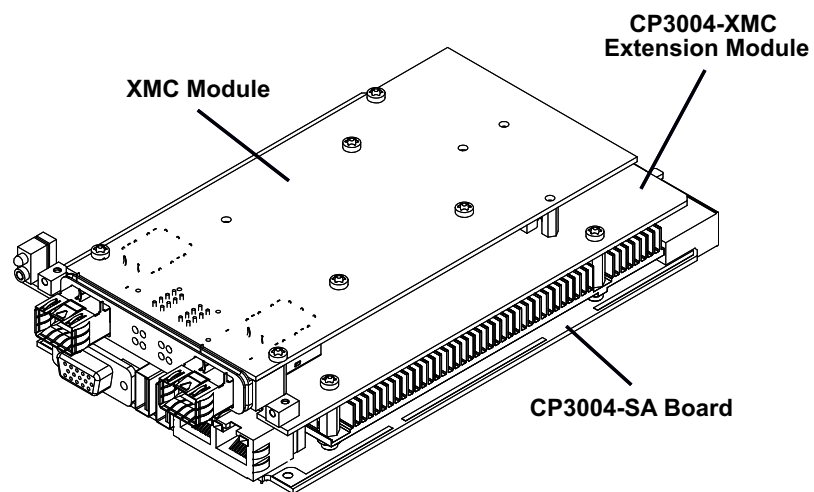
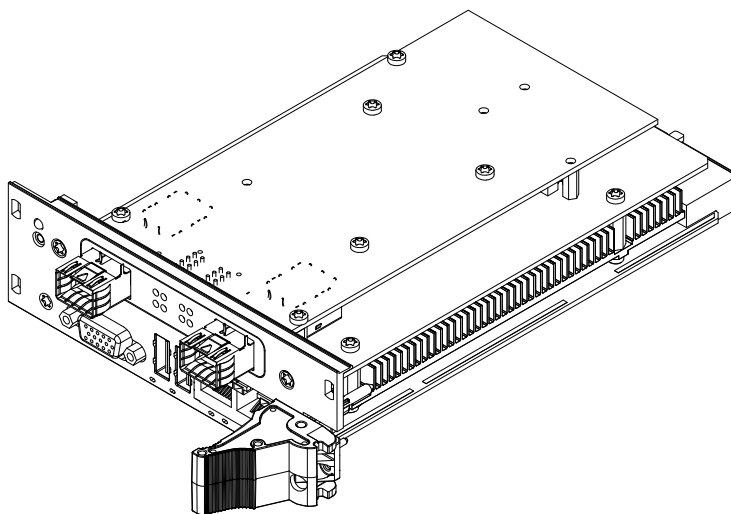

Figure 34: CP3004-SA with Front Panel, CP3004-XMC Extension Module and XMC Module



1. Ensure that no power is applied to the CP3004-SA and disconnect any interfacing cables that may be connected to the board before proceeding.

Note: Even though power may be removed from the system, the CP3004-SA front panel cables and, when installed, the RIO transition module front panel cables may have power applied which comes from an external source. In addition, these cables may be connected to devices that can be damaged by electrostatic discharging or short-circuiting of pins.

It is the responsibility of the system designer or integrator to ensure that appropriate measures are taken to preclude damage to the system or injury to personnel which may arise from the handling of these cables (connecting or disconnecting).

Kontron disclaims all liability for damages or injuries resulting from failure to comply with the above.

2. Remove the front panel by unscrewing the following screws that are retaining the front panel to the CP3004-SA board:
 - » (a) and (b) near the VGA connector on the front panel
 - » (c) and (d) near the XMC slot on the front panel
 - » (e) and (f) on the board's solder side near the front panel
 Please refer to Figure 31 for the location of the above-mentioned screws.
3. Remove the CP3004-XMC from the CP3004-SA by unscrewing the (g), (h), (i) and (j) screws shown in Figure 31.

4. Turn the XMC module component-side down, align its XMC connector with the CP3004-HDD's XMC connector, J1, and gently press down.
5. Secure the XMC module to the CP3004-XMC by inserting the four screws (k), (l), (m), and (n) supplied with the XMC module through the CP3004-XMC's mounting holes into the XMC module's standoffs and tightening them.

Please refer to Figure 32 for the location of the above-mentioned mounting holes.

6. Align the board-to-board connectors, J5 and J6, on the CP3004-XMC with the board-to-board connectors, J8 and J14, on the CP3004-SA and gently press down.

Please refer to Figure 33 for further information on this instruction.

7. Secure the CP3004-XMC equipped with the XMC module to the CP3004-SA by inserting the screws (g), (h), (i) and (j) removed in step 3 into the respective mounting holes and tightening them.

Please refer to Figure 34 for further information on this instruction.

8. Remove the XMC slot cover plate from the XMC bezel cutout of the CP3004-SA front panel, if mounted.

9. Attach the front panel to the board assembly and secure it with the screws (a), (b), (c), (d), (e), and (f) removed in step 2.

If the XMC module is provided with a rubber seal at the bezel, ensure that the rubber seal is properly seated between the bezel and the front panel cutout when attaching the front panel.

Please refer to Figure 34 for further information on this instruction

The 8 HP CP3004-SA equipped with the CP3004-XMC extension module and an XMC module is now ready for operation. For the operation of the XMC module, refer to appropriate documentation provided with the XMC module.

11.4.6 CFast Card Installation

The 8 HP CP3004-SA provides a CFast card socket via the CP3004-HDD or the CP3004-XMC extension module. For further information regarding the CP3004-HDD module, refer to Chapter 6. For further information regarding the CP3004-XMC module, refer to Chapter 7.

Note: The CP3004-HDD does not support removal and reinsertion of the CFast storage card while the board is in a powered-up state. Connecting the CFast card while the power is on, which is known as "hot plugging", may damage your system.

To preclude damage or data loss when removing the CFast Card, ensure that the operating system has been informed of the pending removal and that the OS has indicated that it is safe to proceed.

11.4.7 Rear I/O Device Installation

The CP-RI03-04 rear transition module does not support hot swapping. Therefore, the system must have power removed to install or remove the CP-RI03-04 rear transition module. Before extracting the CP-RI03-04 rear transition module, ensure that all connected cables are disconnected. For physical installation of rear I/O devices, refer to the documentation provided with the device itself.

Note: VGA and Ethernet can be used either on the front panel or on the rear I/O. COMA can be used either on the 8 HP extension module or on the rear I/O. It is not possible to use any of the above-mentioned interfaces on the front or the 8 HP extension and on the rear I/O simultaneously.

11.5 Battery Replacement

The CP3004-SA RTC may be backed up using a single 3.0 V “coin cell” lithium battery from one of two possible points of installation:

- » onboard
- » on the CP3004-HDD extension module

Only one battery may be installed at a time. Refer to Table 1 for battery requirements. The battery should be replaced only with an identical or equivalent type recommended by the manufacturer.

12 uEFI BIOS

12.1 Starting the uEFI BIOS

The CP3004-SA is provided with a Kontron-customized, pre-installed and configured version of Aptio®V (referred to as uEFI BIOS in this manual), AMI's BIOS firmware based on the Unified Extensible Firmware Interface (uEFI) specification and the Intel® Platform Innovation Framework for EFI. This uEFI BIOS provides a variety of new and enhanced functions specifically tailored to the hardware features of the CP3004-SA.

The uEFI BIOS comes with a Setup program which provides quick and easy access to the individual function settings for control or modification of the uEFI BIOS configuration. The Setup program allows the accessing of various menus which provide functions or access to sub-menus with more specific functions of their own.

To start the uEFI BIOS Setup program, follow the steps below:

1. Power on the board.
2. Wait until the first characters appear on the screen (POST messages or splash screen).
3. Press the key.
4. If the uEFI BIOS is password-protected, a request for password will appear.
Enter either the User Password or the Supervisor Password (see Security menu), press <RETURN>, and proceed with step 5.
5. A Setup menu will appear.

The CP3004-SA uEFI BIOS Setup program uses a hot key-based navigation system. A hot key legend bar is located on the bottom of the Setup screens. The following table provides information concerning the usage of these hot keys.

Table 55: Navigation

HOT KEY	DESCRIPTION
→ ←	The <i>Left and Right</i> <Arrow> keys are used to select a major Setup screen. For example: Main Screen, Advanced Screen, Chipset Screen, etc.
↑ ↓	The <i>Up and Down</i> <Arrow> keys are used to select a Setup function or a sub-screen.
+ / -	The <i>Plus and Minus</i> <Arrow> keys are used to change the field value of a particular Setup function, for example, system date and time.
<F1>	The <F1> key is used to invoke the General Help window.
<F2>	The <F2> key is used to restore the previous values.
<F3>	The <F3> key is used to load the defaults for the Setup and the kboardconfig uEFI Shell command.
<F4>	The <F4> key is used to save the current settings and exit the uEFI BIOS Setup.
<K>	The <K> key is used to scroll the help area upwards.
<M>	The <M> key is used to scroll the help area downwards.
<ESC>	The <ESC> key is used to exit a menu or the uEFI BIOS Setup. Pressing the <ESC> key in a sub-menu causes the next higher menu level to be displayed. When the <ESC> key is pressed in a major Setup menu, a pop-up window will appear asking the user if he wants to exit the uEFI BIOS Setup menu without saving.
<Enter>	The <Enter> key is used to execute a command or select a menu.

12.2 Setup Menus

The Setup utility features four menus listed in the selection bar at the top of the screen:

- » Main
- » Advanced
- » Security
- » Boot
- » Save & Exit

The Setup menus are selected via the left and right arrow keys. The currently active menu and the currently active uEFI BIOS Setup item are highlighted in white.

Each Setup menu provides two main frames. The left frame displays all available functions. Functions that can be configured are displayed in blue. Functions displayed in gray provide information about the status or the operational configuration. The right frame displays an Item-Specific Help window providing an explanation of the respective function.

12.2.1 Main Setup Menu

Upon entering the uEFI BIOS Setup program, the Main Setup menu is displayed. This screen lists the Main Setup menu sub-screens and provides basic system information as well as functions for setting the system time and date.

Table 56: Main Setup Menu Sub-Screens and Functions

SUB-SCREEN	FUNCTION	DESCRIPTION
BIOS Information	Project Version, Build Date and Time, etc.	Read-only field. Displays information about the system BIOS. Information about the running uEFI BIOS is reflected in the display-only function "Project Version" (parameter "10.00" indicates Rev. 10).
Processor Information	Name, Brand String, Frequency, Total Memory	Read-only field. Displays information about the processor and the memory.
System Language	English	Selects the system language. Currently, only English is supported
System Date	<WD MM/DD/YYYY>	Changes the system date. Select the system date using the Up and Down <Arrow> keys. Enter the new values through the keyboard or press +/- to increment/decrement values. Use "Tab" to switch between date elements. The time is in 24-hour format. For example, 5:30 A.M. appears as 05:30:00, and 5:30 P.M. as 17:30:00.
System Time	<HH:MM:SS>	Changes the system time Select the system time using the Up and Down <Arrow> keys. Enter the new values through the keyboard or press +/- to increment/decrement values. Use "Tab" to switch between time elements.
Access Level	Administrator	Read-only field. Displays information about the uEFI BIOS Setup accessibility for the current Setup session. The access level is always "Administrator". There are no limitations in the case that a password is set.

12.2.2 Advanced Setup Menu

The Advanced Setup menu provides sub-screens and functions for advanced configuration.

Note: Setting items on this screen to incorrect values may cause the system to malfunction.

Table 57: Advanced Setup Menu Sub-Screens and Functions

SUB-SCREEN	FUNCTION	DESCRIPTION
Trusted Computing	Security Device Support	Enables/Disables BIOS support for the security device.
	TPM State	Enables/Disables the security device.
PCH-FW Configuration	Me FW Version	Read-only field. Displays information about Intel® Management Engine Firmware.
	Me Firmware Mode	Read-only field. Displays information about Intel® Management Engine Firmware.
	Me Firmware Type	Read-only field. Displays information about Intel® Management Engine Firmware.
	Me Firmware SKU	Read-only field. Displays information about Intel® Management Engine Firmware.
	Firmware Update Configuration	Configures the Management Engine Technology parameters.
Serial Port Console Redirection	COM0 /COM1 The COM0 port corresponds to the COMA port. The COM1 port corresponds to the COMB port.	
	Console Redirection	Enables/Disables console redirection over serial port.
	Console Redirection Settings	
	Terminal Type	Selects the terminal type to be emulated.
	Bits per second	Selects the transmission speed of the serial port.
	Data Bits	Specifies the number of data bits per frame.
	Parity	Selects the parity for the serial port.
	Stop Bits	Specifies the number of stop bits for the serial port.
	Flow Control	Specifies the type of flow control to be used for this serial port.
	VT-UTF8 Combo Key Support	Enables/Disables VT-UTF8 Combination Key Support for ANSI/ VT100 terminals.
	Recorder Mode	Specifies if display formatting characters are to be transmitted along with data or if only data is to be transmitted.
	Resolution 100x31	Enables/Disables extended terminal resolution.
	Legacy OS Redirection Resolution	Specifies the number of rows and columns for legacy OS redirection.
	Putty KeyPad	Selects the FunctionKey and the KeyPad on Putty.
	Redirection After BIOS POST	Enables/Disables redirection after BIOS POST.
	Legacy Console Redirection	
	Legacy Console Redirection Settings	
	Legacy Serial Redirection Port	Selects a COM port (COM0 or COM1) to display redirection of Legacy OS and Legacy OPROM messages.

Table 57: Advanced Setup Menu Sub-Screens and Functions (Continued)

SUB-SCREEN	FUNCTION	DESCRIPTION
Serial Port Console Redirection	Serial Port for Out-of-Band Management / Windows Emergency Management Services (EMS)	
	Console Redirection	Enables / Disables console redirection
	Console Redirection Settings	
	Out-of-Band Mgmt Port	Selects a COM port (COM0 or COM1) for remote management of a Windows Server OS.
	Terminal Type	Selects the terminal type to be emulated.
	Bits per second	Selects the transmission speed of the serial port.
	Flow Control	Specifies the type of flow control to be used for this serial port.
	Data Bits	Read-only field. Displays information about the number of data bits per frame.
	Parity	Read-only field. Displays information about the parity for the serial port.
	Stop Bits	Read-only field. Displays information about the number of stop bits for the serial port.
Intel ICC	Clock Manipulation	
	Clock 3 BCLK, DMI, PEG, PCIe, PCI33, SATA, USB3	
	Maximum supported frequency	Read-only field. Displays information about the frequency of the integrated clock.
	Minimum supported frequency	Read-only field. Displays information about the frequency of the integrated clock.
	Current frequency	Read-only field. Displays information about the frequency of the integrated clock.
	Supported SSC modes	Read-only fields.
	Current SSC mode	Display information about the clock spectrum spread mode of the integrated clock.
	New SSC Mode	Specifies the SSC mode.
	Maximum supported SSC %	Read-only field. Displays information about the clock spectrum spread.
	Current SSC %	Read-only field. Displays information about the clock spectrum spread.
	New SSC spread [0.01%]	Specifies the SSC percent in 0.01 increments.
	Apply settings immediately	Specifies whether the settings are applied immediately.
	USB Configuration	XHCI Mode

12.2.3 Security Setup Menu

The Security Setup menu provides information about the passwords and functions for specifying the security settings. The passwords are case-sensitive. The CP3004-SA provides no factory-set passwords.

Table 58: Security Setup Menu Functions

FUNCTION	DESCRIPTION
Password Description	Read-only field.
Administrator Password	Sets, changes or clears the Administrator Password. To set a password, enter it twice and acknowledge by pressing Return.
User Password	Sets, changes or clears the User Password. To set a password, enter it twice and acknowledge by pressing Return.
HDD Security Configuration	Allows access to set, modify and clear the Harddisk User Password. The Harddisk User Password must be set to enable haddisk security

Note: If there is already a password installed, the system asks for this first. To clear a password, simply enter nothing and acknowledge by pressing <RETURN>. To set a password, enter it twice and acknowledge by pressing <RETURN>.

Table 59: Modes of Security

SETTING	DESCRIPTION
No password is set	Booting the system as well as entering the Setup is unsecured.
Only Administrator password is set	Booting the system is unsecured. For entering the Setup, the Administrator password is required.
Only User password is set	The password is required for booting the system as well as for entering the Setup menu. On every startup, the user will be asked for the password.
Both User and Administrator passwords are set	Either the User or the Administrator password is required for booting the system as well as for entering the Setup menu. If the User password is entered here, limited access to the Setup is granted. Entering the Administrator password provides full access to all Setup entries.

12.2.3.1 Remember the Password

It is highly recommended to keep a record of all passwords in a safe place. Forgotten passwords may lead to being completely locked out of the system.

If the system cannot be booted because neither the User Password nor the Administrator Password are known, refer to the section 3.1, for information about clearing the uEFI BIOS settings, or contact Kontron for further assistance.

Note: The HDD User Password cannot be cleared using the above method.

12.2.4 Boot Setup Menu

The Boot Setup menu provides sub-screens and functions for boot configuration and shows the boot device priority order, which is dynamically generated.

Table 60: Boot Setup Menu Sub-Screens and Functions

SUB-SCREEN	FUNCTION	DESCRIPTION
Boot Configuration	Fast Boot	Enables/Disables boot with initialization of a minimal set of devices required to launch active boot option.
Boot Option Priorities	Boot option #1..2	These functions are automatically generated and are used to form the boot order. They represent either a legacy BBS (BIOS Boot Specification) class of devices or a native EFI boot entry. Press Return on each option to select the BBS class / EFI boot entry desired.
	Hard Drive BBS Priorities	These functions are automatically generated and are used to configure the boot order for a specific device.

12.2.5 Save & Exit Setup Menu

The Save & Exit Setup menu provides functions for handling changes made to the uEFI BIOS settings and the exiting of the Setup program.

Note: The Setup will ask for confirmation prior to executing the commands.

Table 61: Save & Exit Setup Menu Sub-Screens and Functions

SUB-SCREEN	FUNCTION	DESCRIPTION
Save & Exit	Save Changes and Exit	Equal to F4. Saves all changes made within the Setup to flash, then exits the uEFI BIOS Setup, and finally resets the system automatically. This function continues the boot process as long as no option was altered that requires a reboot.
	Discard Changes and Exit	Discards all changes made within the Setup, then exits the uEFI BIOS Setup. This function continues the boot process.
	Save Changes and Reset	Saves all changes made within the Setup to flash and resets the system.
	Discard Changes and Reset	Discards all changes made within the Setup and resets the system.
Save Options	Save Changes	Saves all changes made within the Setup to flash but does not reset system. This function returns to Setup.
	Discard Changes	Discards all changes made within the Setup but does not reset system. This function returns to Setup.
	Restore Defaults	Equal to F3. Restores/Loads the factory default values for all setup options.
	Save as User Defaults	Saves all current settings as user default. The current setup state can later be restored using Restore User Defaults.
	Restore User Defaults	Restores all tokens to settings previously stored by Save as User Defaults.
Boot Override	UEFI: Built-in EFI Shell	This group of functions includes a list of tokens, each of them corresponding to one device within the boot order. Select a drive to immediately boot that device regardless of the current boot order. If booting to EFI Shell this way, an exit from the shell returns to Setup.
	P0: TOSHIBA MK1676GSX	

12.3 The uEFI Shell

The Kontron uEFI BIOS features a built-in and enhanced version of the uEFI Shell. For a detailed description of the available standard shell scripting refer to the EFI Shell User's Guide. For a detailed description of the available standard shell commands, refer to the EFI Shell Command Manual. Both documents can be downloaded from the EFI and Framework Open Source Community homepage (<http://sourceforge.net/projects/efi-shell/files/documents/>).

Please note that not all shell commands described in the EFI Shell Command Manual are provided by the Kontron uEFI BIOS.

12.3.1 Introduction, Basic Operation

The uEFI Shell forms an entry into the uEFI boot order and is the first boot option by default.

12.3.1.1 Entering the uEFI Shell

To enter the uEFI Shell, follow the steps below:

1. Power on the board.
2. Press the ESC key within 5 seconds after a message such as the one below appears:

```
UEFI Interactive Shell v2.0
EDK II
UEFI v2.40 (American Megatrends, 0x0005000A)
Mapping table
blk0      :Removable HardDisk - Alias hd33b0b0b fs0
          Acpi (PNP0A03,0) /Pci (1D|7) /Usb (1, 0) /Usb (1, 0) /HD (Part1,Sig17731773)
...
Press the ESC key within 5 seconds to skip startup.nsh, and any other key to
continue.
```

The output produced by the device mapping table can vary depending on the board's configuration.

If the ESC key is pressed before the 5-second timeout has elapsed, the shell prompt is shown:

```
Shell>
```

12.3.1.2 Exiting the uEFI Shell

To exit the uEFI Shell, follow one of the steps below:

1. Invoke the **exit** uEFI Shell command to select the boot device in the boot menu for the OS to boot from.
2. Reset the board using the **reset** uEFI Shell command.

12.3.2 Kontron-Specific uEFI Shell Commands

The Kontron uEFI implementation provides the following additional commands related to the specific HW features of the Kontron system.

Table 62: Kontron-Specific uEFI Shell Commands

COMMAND	DESCRIPTION
kboardconfig	<p>Configures non-volatile board settings, such as:</p> <ul style="list-style-type: none"> » Pxe » PrimaryDisplay » Vga » SataMode » SataSpeed » Sata2Hotplug » Sata3Hotplug » IntelVT » IntelHT » SpeedStep » CpuTurbo » C3State » C6State » C7State » cTDP » WrProtSystem » WrProtSata » GbeA » GbeB » ComA » AutoUpdate <p>Note: If AutoUpdate is enabled, an automatic update procedure from the connected mass storage device is initiated after a reset. The update status is indicated in the log file located in the directory where the firmware images are stored.</p> <ul style="list-style-type: none"> » ShellTimeOut » cPCISlotClockOut0..7 <p>Note: The parameters of the kboardconfig command are not case-sensitive.</p>
kboardinfo	Shows a summary of board-specific data and displays/checks various parameters such as the current uEFI BIOS revision, etc.
kboot	<p>Boots a legacy OS</p> <p>Not to be used for uEFI BootLoaders!</p> <p>If the requested device is not present, boot returns to shell. This command cannot boot native uEFI-aware operating systems. But since these are bootable from shell by calling their boot-loader, this is not necessary either. If a requested device is present but not bootable, uEFI continues to boot with the next bootable device in the boot order.</p>
kbootscript	<p>Manages the flash-stored startup script</p> <p>If the shell is launched by the boot process, it executes a shell script stored in the flash. If the shell script terminates, the shell will continue the boot process. However, the shell script can also contain any other boot command.</p>

Table 62: Kontron-Specific uEFI Shell Commands

COMMAND	DESCRIPTION
kflash	Programs and verifies the SPI boot flashes holding the uEFI BIOS code uEFI BIOS binary files must be available from connected mass storage devices, such as USB flash drive or harddisk.
kjtag	Programs an onboard device via the JTAG interface
knvram	Manages the NVRAM to restore the system's default settings Since all uEFI settings are stored inside the NVRAM, the default settings are loaded after invoking this command.
kpassword	Controls uEFI Setup and Shell passwords This command is used to determine the status of both passwords (set or not set) and to set or clear the uEFI Shell and Setup passwords. Both user and superuser (Supervisor) passwords can be controlled with this command. Call without options to get current password status. Entering an empty password clears the password.
kramdisk	Creates and manages RAMdisks This command is used to perform file operations when no real filesystem is connected to the system.
kreset	Controls the board's reset behavior This command controls if the board shall react on a CompactPCI backplane reset if it is used in a peripheral slot. It has no effect if the board is installed in the CompactPCI system slot. The parameter of this command is volatile and set to off at the next start.
kupdate	Controls the Kontron common update tool When using the kupdate command, the structure of the ZIP archive must not be altered. kupdate automatically starts the update procedure via kupdate -u . If a certain image is intended to be used, enter kupdate -s to select the respective image.
kwatchdog	Configures the Kontron onboard Watchdog This command is used to enable the Kontron onboard Watchdog with reset target before OS boot. This can be used to detect if the OS fails to boot and react by reset.

The uEFI Shell commands are not case-sensitive. Each uEFI Shell command is provided with a detailed online help that can be invoked by entering "`<cmd> <space> <-?>`" in the command line. To display the uEFI Shell command list, enter `<help>` or `<?>` in the command line.

12.4 uEFI Shell Scripting

12.4.1 Startup Scripting

If the ESC key is not pressed and the timeout is run out, the uEFI Shell tries to execute some startup scripts automatically. It searches for scripts and executes them in the following order:

1. Kontron flash-stored startup script
2. If there is no Kontron flash-stored startup script present, the uEFI-specified `startup.nsh` script is used. This script must be located on the root of any of the attached FAT formatted disk drive.
3. If none of the startup scripts is present or the startup script terminates, the default boot order is continued.

12.4.2 Create a Startup Script

Startup scripts can be created using the uEFI Shell built-in editor `edit` or under any OS with a plain text editor of your choice. To create a startup shell script, simply save the script on the root of any FAT-formatted drive attached to the system. To copy the startup script to the flash use the `kbootscript` uEFI Shell command.

In case there is no mass storage device attached, the startup script can be generated in a RAM disk and stored in the SPI boot flash using the `kramdisk` uEFI Shell command.

12.4.3 Examples of Startup Scripts

12.4.3.1 Automatic Booting from USB Flash Drive

Automatic booting is made from a USB flash drive, if present, otherwise the boot is made from the harddrive.

```
kboot -t usb-harddrive  
kboot -t harddrive
```

If neither a USB flash drive nor a harddrive is present, the boot order is continued.

12.4.3.2 Execute Shell Script on Other Harddrive

This example (`startup.nsh`) executes the shell script named `bootme.nsh` located in the root of the first detected disc drive (`fs0`).

```
fs0:  
bootme.nsh
```

12.4.3.3 Enable Watchdog and Control PXE Boot

The uEFI Shell provides environment variables used to control the execution flow.

The following sample start-up script shows two uEFI Shell environment variables, `wdt_enable` and `pxe_first`, used to control the boot process and the Watchdog.

```
echo -off
echo "Executing sample startup.nsh..."
if %wdt_enable% == "on" then
    kwdt -t 15
    echo "Watchdog enabled"
endif
if %pxe_first% == "on" then
    echo "forced booting from network"
    kboot -t network
endif
```

To create uEFI Shell environment variables, use the **set** uEFI Shell command as shown below:

```
Shell> set wdt_enable on
Shell> set pxe_first on
Shell> set
    pxe_first : on
    wdt_enable : on
Shell> reset
```

12.4.3.4 Handling the Startup Script in the SPI Boot Flash

In case there is no mass storage device attached, the startup script can be generated in a RAM disk and stored in the SPI boot flash using the following instructions:

1. Press <ESC> during power-up to log into the uEFI Shell.
2. Create a RAM disk and set the proper working directory as shown below:

```
Shell> kramdisk -s 3 myramdisk
Shell> myramdisk:
```

3. Enter the sample start-up script mentioned above in this section using the **edit** uEFI Shell command.

```
myramdisk:\> edit boot.nsh
```

4. Save the start-up script to the SPI boot flash using the **kbootscript** uEFI Shell command.

```
myramdisk:\> kbootscript -p boot.nsh
```

5. Reset the board to execute the newly installed script using the **reset** uEFI Shell command.

```
myramdisk:\> reset
```

6. If a script is already installed, it can be edited using the following **kbootscript** uEFI Shell commands.

```
myramdisk:\> kbootscript -g boot.nsh
myramdisk:\> edit boot.nsh
```

12.5 Updating the uEFI BIOS

The CP3004-SA has two SPI boot flashes programmed with the uEFI BIOS, a standard SPI boot flash and a recovery SPI boot flash. The basic idea behind that is to always have at least one working uEFI BIOS flash available regardless if there have been any flashing errors or not.

12.5.1 Updating Procedure

The standard SPI boot flash can be updated with the latest uEFI BIOS from the ZIP archive using the **kupdate -u** or the **kflash -p** uEFI Shell command. When using the **kupdate** command, the directory structure of ZIP archive must not be altered. The update status is indicated in the log file located in the directory where the firmware images are stored.

12.5.2 uEFI BIOS Recovery

In case of the standard SPI boot flash being corrupted and therefore the board not starting up, the board can be booted from the recovery SPI boot flash if the DIP switch SW1, switch 2 is set to ON. For further information, refer to the section 3.1 DIP Switch Configuration.

Note: The uEFI BIOS code and settings are stored in the SPI boot flashes. Changes made to the uEFI BIOS settings are available only in the currently selected SPI boot flash. Thus, switching over to the other SPI boot flash may result in operation with different uEFI BIOS code and settings.

Note: To make the standard SPI boot flash bootable again, invoke the **kflash -c** uEFI Shell Command. Hence, the content of the recovery SPI boot flash is copied to the standard SPI boot flash.

12.5.3 Determining the Active Flash

Sometimes it may be necessary to check which flash is active. On the AMI Aptio-based uEFI BIOS, the information is available using the **kboardinfo** uEFI Shell command.

CORPORATE OFFICES**Europe, Middle East & Africa**

Lise-Meitner-Str. 3-5
86156 Augsburg
Germany
Tel.: + 49 (0) 821 / 4086 0
Fax: + 49 (0) 821 / 4086 111
info@kontron.com

North America

14118 Stowe Drive
Poway, CA 92064-7147
USA
Tel.: + 1 888 294 4558
Fax: + 1 858 677 0898
info@us.kontron.com

Asia Pacific

17 Building, Block #1, ABP.
188 Southern West 4th Ring Road
Beijing 100070, P.R.China
Tel.: + 86 10 63751188
Fax: + 86 10 83682438
info@kontron.cn